

**WECO, GTE AND OTHER MANUFACTURERS
FOUR AND FIVE CONDUCTOR CORD ASSEMBLIES
DESCRIPTION**

1. GENERAL

1.01 This section provides a listing and illustration of cord assemblies with four and five conductors manufactured by Western Electric Company and manufacturers other than GTE Automatic Electric and GTE Lenkurt. Also shown are cord assemblies which may be assembled for or by any of the GTE Operating Companies.

1.02 This section is reissued to remove the GTE Automatic Electric and GTE Lenkurt cord assemblies. For GTE AE cord assemblies, refer to the 032-210 series of GTE Practices. For GTE Lenkurt cord assemblies, see Section 032-201-150.

1.03 For an explanation of the numbering plan for these cord assemblies, see Section 032-201-101.

1.04 Remove and destroy all copies of Section 032-201-105, Issue 1.

2. DESCRIPTION

2.01 For each illustrated cord assembly, a wiring diagram, and all plugs, terminals, and receptacles are shown. A stocklist of major components is also provided.

2.02 Cord assemblies of 1, 2, 3, 6 and 7, and 8 or more conductors are covered in other sections in the 032-201 series of GTE Practices.

2.03 The following are WECO, GTE or other manufacturers cord assemblies with four and five conductors, arranged in alpha-numeric order.

4P2A (MFGR. DISC.)

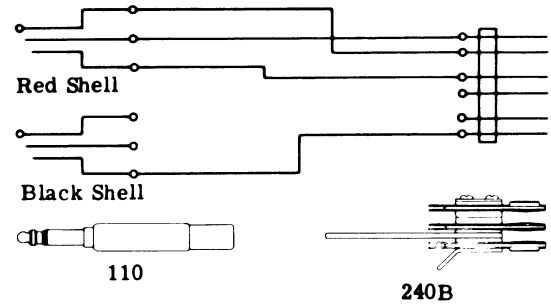

- (1) W. E. Co., Cord Assembly Consisting of:
- (2) 110 Plugs
- (1) 240B Plug
- (2) P3H Slate Cords (10 Ft. Long)

(Replaced by 5P3A Cord Assembly)

4P4B

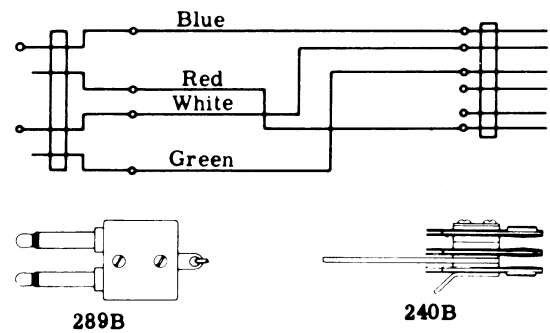

- (1) W. E. Co., Cord Assembly Consisting of:
- (1) 289B Plug (Black)
- (1) 240B Plug
- (1) P4K Black Cord (12 Ft. Long)

4P8A

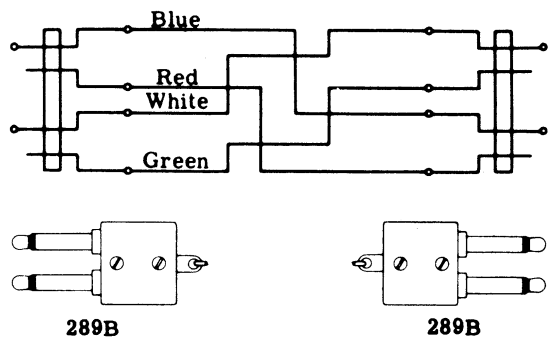

- (1) W. E. Co. , Cord Assembly Consisting of:
- (2) 289B Plugs (Black)
- (1) P4N Slate Cord (4 Ft. Long)

4P19A

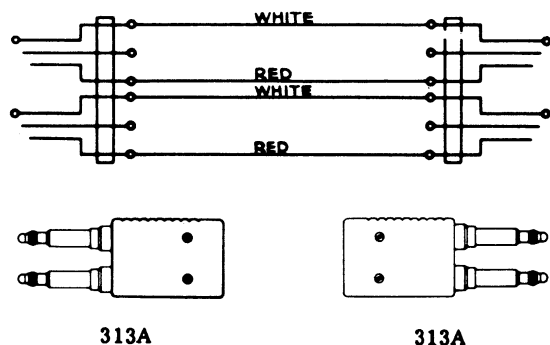

- (1) W. E. Co. , Cord Assembly Consisting of:
- (2) 313A Plugs
- (1) P4AB Slate Cord (8 Ft. Long)

4P21A

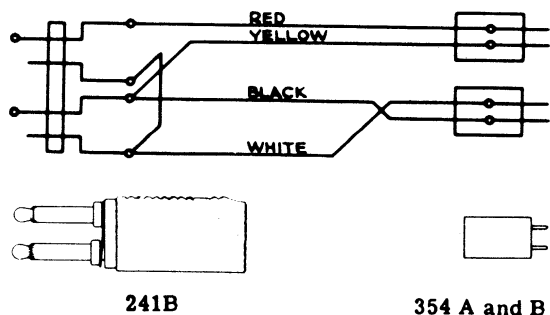

- (1) W. E. Co. , Cord Assembly Consisting of:
- (1) 241B Plug
- (1) 354A Plug
- (1) 354B Plug
- (1) P4AD Brown Cord (6 Ft. Long)

4P22A

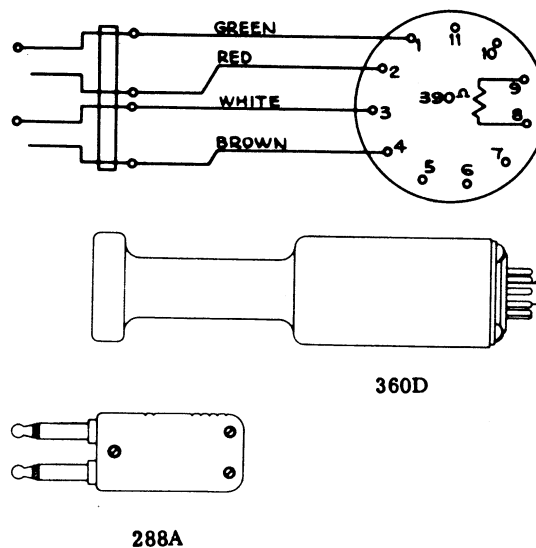

- (1) W. E. Co. , Cord Assembly Consisting of:
- (1) 288A Plug
- (1) 360D Plug
- (1) P4AE Brown Cord (7 Ft. Long)

4PG1N (MFGR. DISC.)

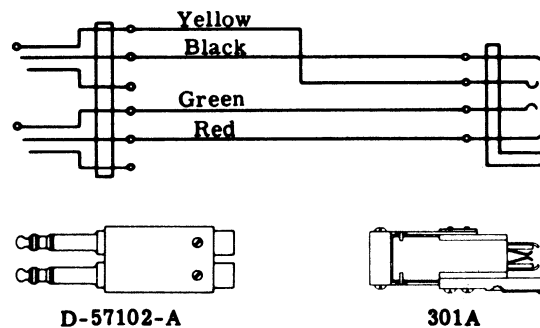

- (1) G. T. Co. , Cord Assembly Consisting of:
- (1) D-57102-A Plug (Red Shell) (GTE AE)
- (1) 301A Test Plug (W. E. Co.)
- (1) T402-D Cord (25 Ft. Long) (Whitney Blake)

(Replaced by 4PG3R Cord Assembly)

4PG1S (MFGR. DISC.)

Same as 4PG1N except that T402-D cord is 15 ft. long.

(Replaced by 4PG3R Cord Assembly)

4PG4V

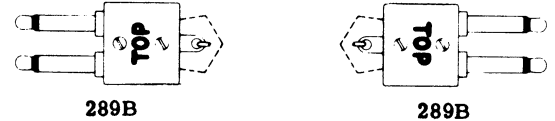
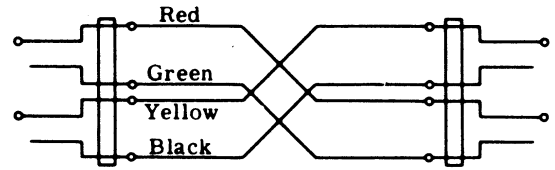

289B

289B

- (1) G. T. Co. , Cord Assembly Consisting of:
- (2) 289B Plugs (W. E. Co.)
- (1) T402-D-171 Black Cord (10 Ft. Long) (Whitney Blake)

4PG2L

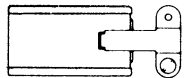

S-404 CCT

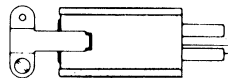

P-404 CCT

- (1) G. T. Co. , Cord Assembly Consisting of:
- (1) P-404 CCT Plug (Cinch-Jones)
- (1) S-404 CCT Socket (Cinch-Jones)
- (1) 8454 Cable (30 Ft. Long) (Belden Mfg. Co.)

4PG3R

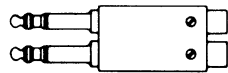
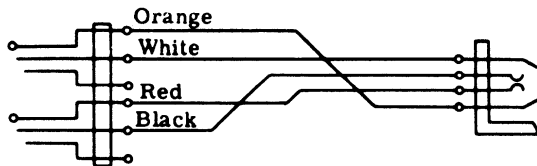

D-57102-A



301A

- (1) G. T. Co. , Cord Assembly Consisting of:
- (1) 301A Test Plug (W. E. Co.)
- (1) D-57102-A Twin Plug (Red Shell) (GTE AE)
- (1) D-542613-B Cord (18 Ft. Long) (GTE AE)

(Replaces 4PG1N and 4PG1S Cord Assemblies)

4PG5U

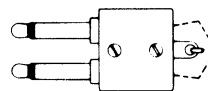
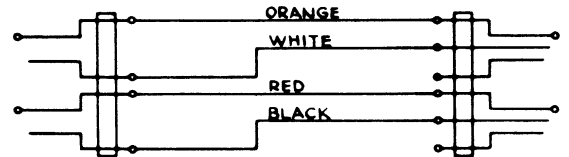

289B



D-57102-A

- (1) G. T. Co. , Cord Assembly Consisting of:
- (1) 289B Plug (W. E. Co.)
- (1) D-57102-A Twin Plug (Red Shell) (GTE AE)
- (1) D-542613-A Cord Assembly (12 Ft. Long) (GTE AE)

4PG6S

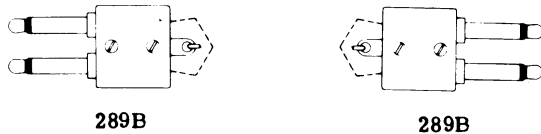
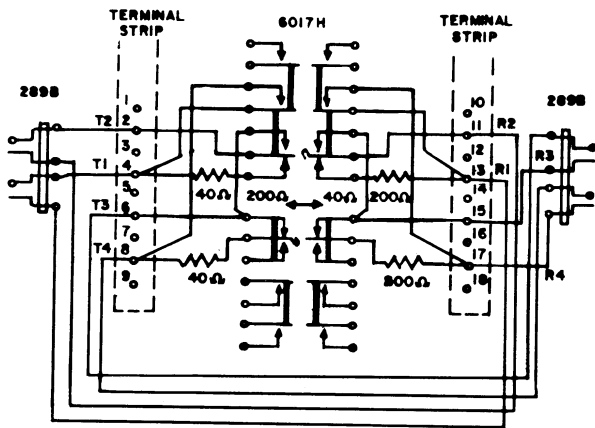

- (1) G. T. Co., Cord Assembly Consisting of:
 (2) 289B Plugs (W. E. Co.)
 (8) 140 Cord Tips (W. E. Co.)
 (1) 6017-R Key (W. E. Co.)
 (8) 144 Cord Tips (W. E. Co.)
 (2) CPS 1/2 Watt $40\Omega + 1\%$ Carbonfilm Resistors (Aerovox)
 (2) CPS 1/2 Watt $200\Omega + 1\%$ Carbonfilm Resistors (Aerovox)
 (4) 77 Cord Tips (Rubber Insulators (W. E. Co.)
 (2) 126 Cord Tips (Insulated Tubing) (W. E. Co.)
 (1) T402-D-171 Cord (Black) (15 Ft. Long) (Whitney Blake)

4WG1S

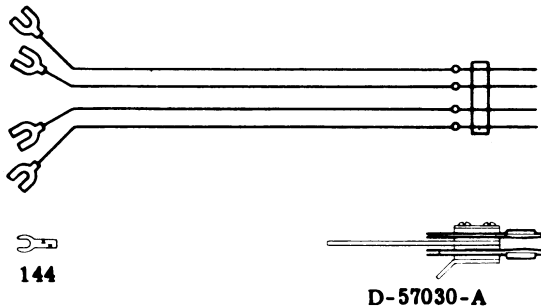

- (1) G. T. Co., Cord Assembly Consisting of:
 (4) 144 Cord Tips (W. E. Co.)
 (1) D-57030-A Plug (GTE AE)
 (1) T402-D Cord (15 Ft. Long) (Whitney Blake)

4WG2W

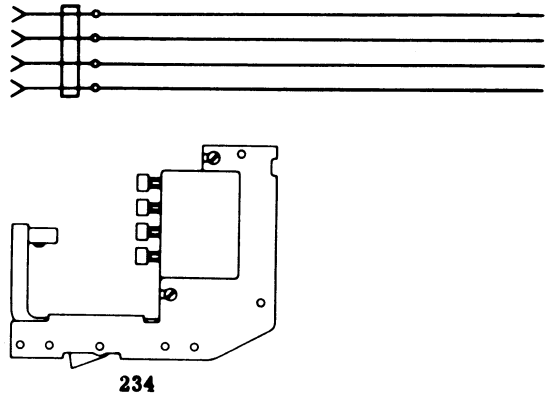

- (1) G. T. Co., Cord Assembly Consisting of:
 (1) 234 Plug (W. E. Co.)
 (4) 121 Cord Tips (W. E. Co.)
 (1) 8424 Cord (7 Ft. Long) (Belden Mfg. Co.)

4WG3U (MFGR. DISC.)

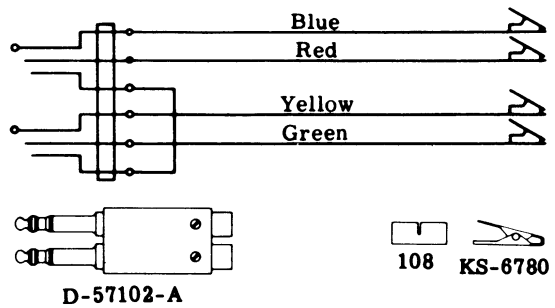

- (1) G. T. Co., Cord Assembly Consisting of:
 (1) D-57102-A Plug (Red Shell)(GTE AE)
 (4) KS-6780 Clips (W. E. Co.)
 (4) 108 Cord Tips (Rubber Insulators) (W. E. Co.)
 (1) W4AD Black Cord (12 Ft. Long)(W. E. Co.)

(Replaced by 4WG6U Cord Assembly)

4WG4X

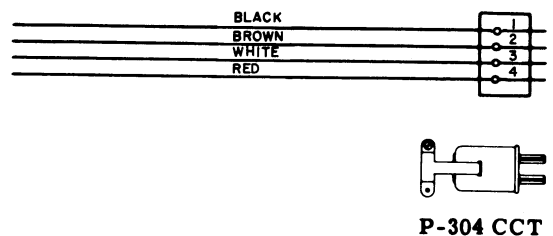

- (1) G. T. Co., Cord Assembly Consisting of:
 (1) P-304 CCT Plug (Cinch-Jones)
 (1) 8454 Cordage (5 Ft. Long) (Belden Mfg. Co.)

4WG5V

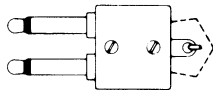
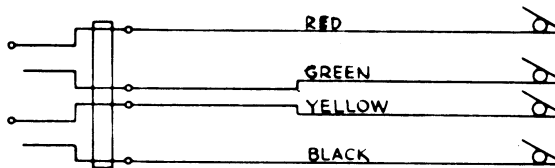

289B

63

- (1) G. T. Co. , Cord Assembly Consisting of:
- (1) 289B Plug (W. E. Co.)
- (4) 63 Insulated Alligator Clips (Mueller Elec. Co.)
- (8) 140 Cord Tips (W. E. Co.)
- (2) 77 Cord Tips (Rubber Insulators)(W. E. Co.)
- (1) P-360424 Hook (Stay Hook) (W. E. Co.)
- (1) 126 Cord Tip (Insulated Tubing) (W. E. Co.)
- (1) T-402-D-171 Cord (Black) (Whitney Blake)

5P3A

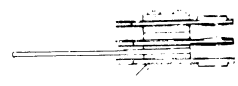
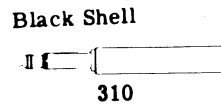
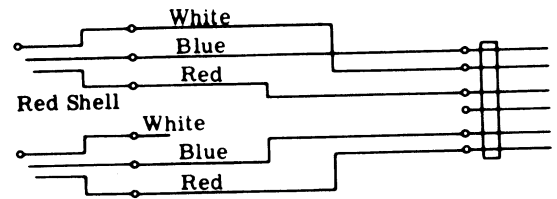

310

240B

- (1) W. E. Co. , Cord Assembly Consisting of:
- (2) 310 Plugs
- (1) 240B Plug
- (2) P3H Slate Cords (10 Ft. Long)

(Replaces 4P2A Cord Assembly)

4WG6U

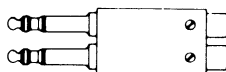
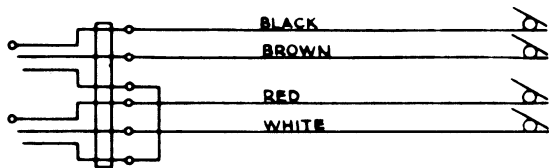

D-57102-A

KS-6780

- (1) G. T. Co. , Cord Assembly Consisting of:
- (1) D-57102-A Plug (Red Shell) (GTE AE)
- (4) KS-6780 Connecting Clips (W. E. Co.)
- (4) 108 Cord Tips (Rubber Insulators) (W. E. Co.)
- (2) EP-14-1/2" x 3" Transparent Sleeve (Resinite)
- (1) 8454 Cordage (4 Conductor) (12 Ft. Long) (Belden Mfg. Co.)

(Replaces 4WG3U Cord Assembly)

4019N

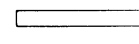
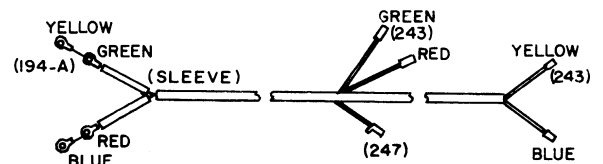

194-A

Soft Rubber Sleeve

247

243

- (1) Runzel Cord and Wire Co. , Cord Assembly Consisting of:
- (2) Soft Rubber Sleeves
- (4) 194-A Cord Tips
- (1) 247 Cord Tip
- (4) 243 Cord Tips
- (1) Four Conductor Black Cord (5 Ft. Long)

KS-5785 List 2

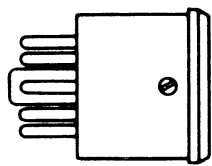
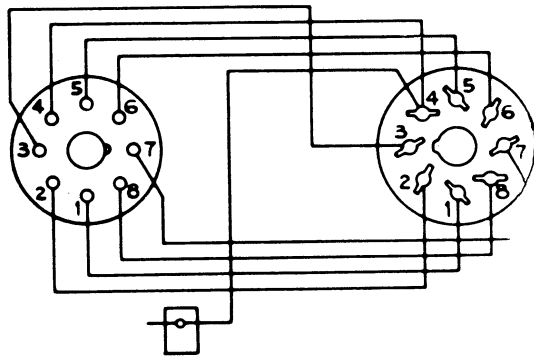

50-8SD 44-8



868

- (1) W. E. Co., Cord Assembly Consisting of:
- (1) 44-8 Adapter Top Socket (Amphenol)
- (1) 50-8SD Adapter Base (Amphenol)
- (1) 868 Elbow Tip (Red) (I. C. A.)
- (1) 309 Cord (Red) (4 Ft. Long) (I. C. A.)

L4AH

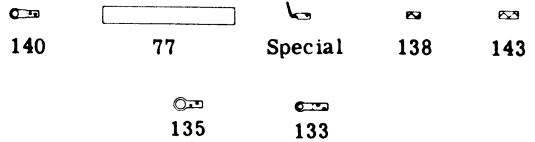
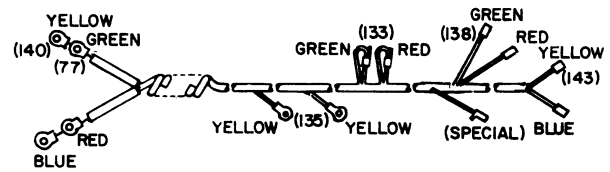

- (1) W. E. Co., Cord Assembly Consisting of:
- (2) 77 Cord Tips (Rubber Insulators)
- (4) 140 Cord Tips
- (2) 135 Cord Tips
- (2) 133 Cord Tips
- (1) Special Cord Tip
- (2) 138 Cord Tips
- (2) 143 Cord Tips
- (1) Brown Retractable 4 Conductor Cord (10 Ft. Usable Length)

L4AG

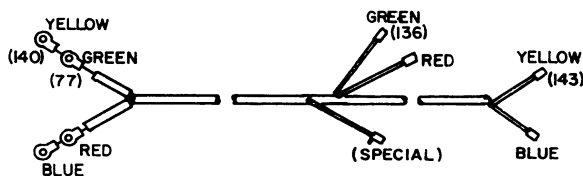

- (1) W. E. Co., Cord Assembly Consisting of:
- (2) 77 Cord Tips (Rubber Insulators)
- (4) 140 Cord Tips
- (2) 138 Cord Tips
- (1) Special Cord Tip
- (2) 143 Cord Tips
- (1) Four Conductor Black Cord (5 Ft. Long)

L4AK

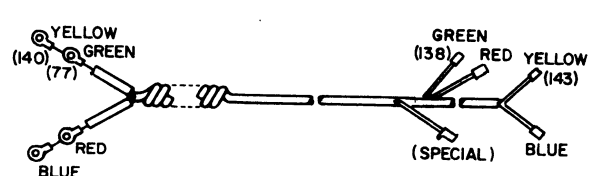

- (1) W. E. Co., Cord Assembly Consisting of:
- (2) 77 Cord Tips (Rubber Insulators)
- (4) 140 Cord Tips
- (1) Special Cord Tip
- (2) 138 Cord Tips
- (2) 143 Cord Tips
- (1) Brown Retractable 4 Conductor Cord (15 Ft. Usable Length)

P5B

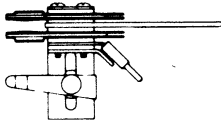
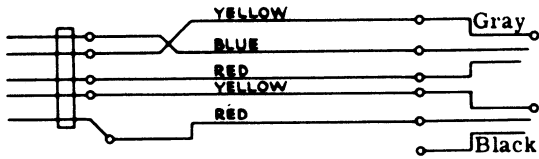

240H

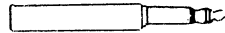

310

- (1) W. E. Co., Cord Assembly Consisting of:
- (1) 310 Plug (Black)
- (1) 310 Plug (Gray)
- (1) 240H Plug
- (1) P5B Black Cord (7 Ft. Long)

W4AU

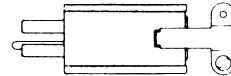
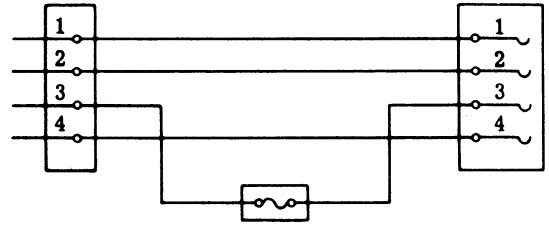

KS-8585-L9

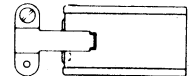

KS-8586-L6

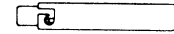

Fuse

- (1) W. E. Co., Cord Assembly Consisting of:
- (1) KS-8585-L9 Plug
- (1) KS-8586-L6 Socket
- (1) Fuse Holder
- (1) 1/8 Amp Fuse
- (1) 4 Conductor Brown Cord (6 Ft. Long)