

WECO, GTE AND OTHER MANUFACTURERS
TWO CONDUCTOR CORD ASSEMBLIES
DESCRIPTION

1. GENERAL

1.01 This section provides a listing and illustration of cord assemblies with two conductors manufactured by Western Electric Company and manufacturers other than GTE Automatic Electric and GTE Lenkurt. Also shown are cord assemblies which may be assembled for or by any of the GTE Operating Companies.

1.02 This section is reissued to remove the GTE Automatic Electric and GTE Lenkurt cord assemblies. For GTE AE cord assemblies, refer to the 032-210 series of GTE Practices. For GTE Lenkurt cord assemblies, see Section 032-201-150.

1.03 For an explanation of the numbering plan for these cord assemblies, see Section 032-201-101.

1.04 Remove and destroy all copies of Section 032-201-103, Issue 1.

2. DESCRIPTION

2.01 For each illustrated cord assembly, a wiring diagram, and all plugs, terminals, and receptacles are shown. A stocklist of major components is also provided.

2.02 Cord assemblies of 1, 3, 4 and 5, 6 and 7, and 8 or more conductors are covered in other sections in the 032-201 series of GTE Practices.

2.03 The following are WECO, GTE or other manufacturers cord assemblies with two conductors, arranged in alpha-numeric order.

2P1D

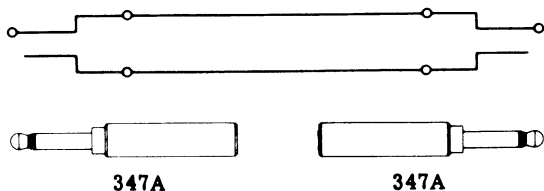

- (1) W. E. Co. , Cord Assembly Consisting of:
- (2) 347A Plugs (Red)
- (1) P2A Red Cord (6 Ft. Long)

2P2A

Same as 2P1D except cord is 3 ft. long.

2P3B

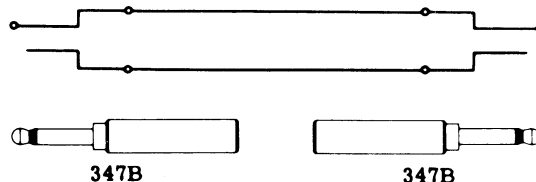

- (1) W. E. Co. , Cord Assembly Consisting of:
- (2) 347B Plugs (Black)
- (1) P2A Red Cord (6 Ft. Long)

2P4A

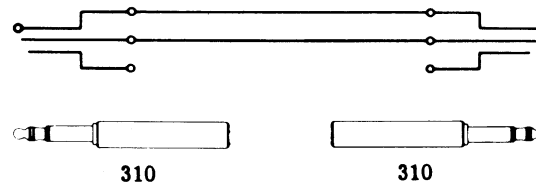

- (1) W. E. Co. , Cord Assembly Consisting of:
- (2) 310 Plugs (Red)
- (1) P2B Green Cord (3 Ft. Long)

2P4B

Same as 2P4A except cord is 4 ft. long.

2P4C

Same as 2P4A except cord is 6 ft. long.

SECTION 032-201-103
ISSUE 2

2P9A

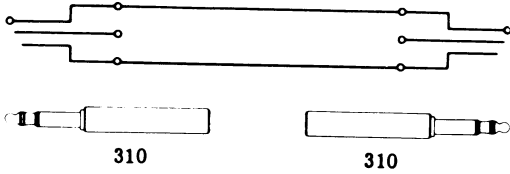

- (1) W. E. Co. , Cord Assembly Consisting of:
- (2) 310 Plugs (Red)
- (1) P2J Black Cord (9 Ft. Long)

2P9B

Same as 2P9A except cord is 6 ft. long.

2P9C

Same as 2P9A except cord is 6 ft. long and 310 plugs have black shells.

2P10A

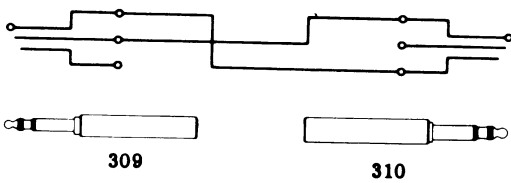

- (1) W. E. Co. , Cord Assembly Consisting of:
- (1) 309 Plug (Red)
- (1) 310 Plug (Red)
- (1) P2P Red-Slate Cord (10 Ft. Long)

2P10B

Same as 2P10A except plug shells are black.

2P12A

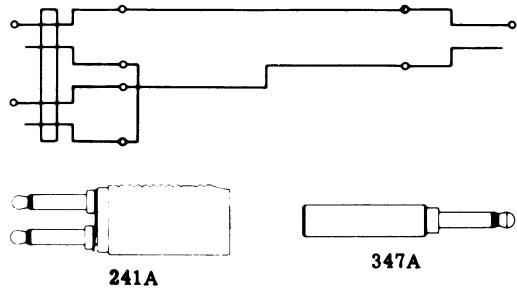

- (1) W. E. Co. , Cord Assembly Consisting of:
- (1) 241A Plug (Black)
- (1) 347A Plug (Red)
- (1) P2T Slate Cord (6 Ft. Long)

2P13A

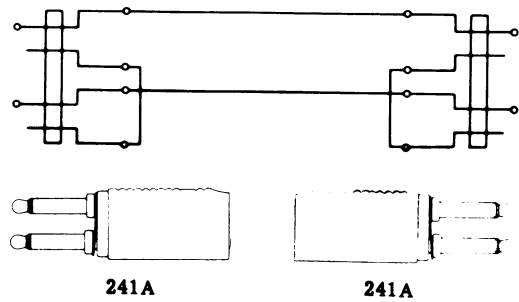

- (1) W. E. Co. , Cord Assembly Consisting of:
- (2) 241A Plugs (Black)
- (1) P2AA Slate Cord (3 Ft. Long)

2P13B

Same as 2P13A except cord is 6 ft. long.

2P13C

Same as 2P13A except cord is 15 ft. long.

2P13D

Same as 2P13A except cord is 2 ft. long.

2P14A

Same as 2P13A except red 241B plugs are used in place of the black 241A plugs.

2P20A

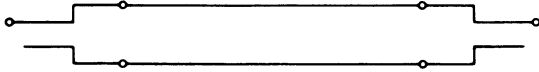

Res. .004 Ω Per Ft.

- (1) W. E. Co., Cord Assembly Consisting of:
- (2) 347B Plugs (Black)
- (1) P2AK Black Cord (8 Ft. Long)

2PG1V

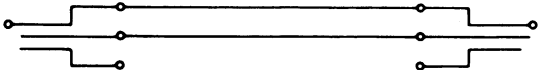

- (1) G. T. Co., Cord Assembly Consisting of:
- (1) 310 Plug (W. E. Co.)
- (1) D-57132-R Plug (GTE AE)
- (1) 2 Conductor Cord (10 Ft. Long)

2PG2V

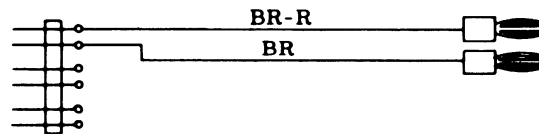

- (1) G. T. Co., Cord Assembly Consisting of:
- (1) D-57037-A Plug (GTE AE)
- (2) 604 Banana Plugs (Red) (Birnbach)
- (1) D-542215 Cord (10 Ft. Long) (GTE AE)

2PG3X (MFGR. DISC.)

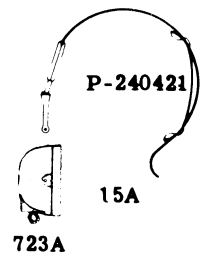
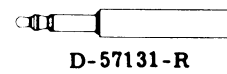
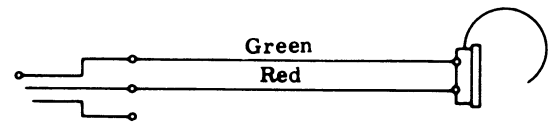

- (1) G. T. Co., Cord Assembly Consisting of:
- (1) D-57131-R Plug (GTE AE)
- (1) 15A Headband (W. E. Co.)
- (1) 723A Receiver Assembly (W. E. Co.)
- (1) P-240421 Rubber Pad (W. E. Co.)
- (1) R2CF Cord (6 Ft. Long) (W. E. Co.)

(Replaced by 2PG15X Cord Assembly)

2PG4Z

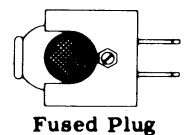
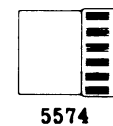
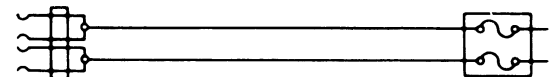

- (1) G. T. Co., Cord Assembly Consisting of:
- (1) 5574 Connector (Hubbell)
- (1) Fused Plug (Elmenco)
- (2) MDX Slow-Blowing 5 Amp Fuses (Buss)
- (1) SI-53184 Type SJ Cord (18 In. Long) (G. E. Co.)

(Replaces 2PG5Z Cord Assembly)

2PG5Z (MFGR. DISC.)

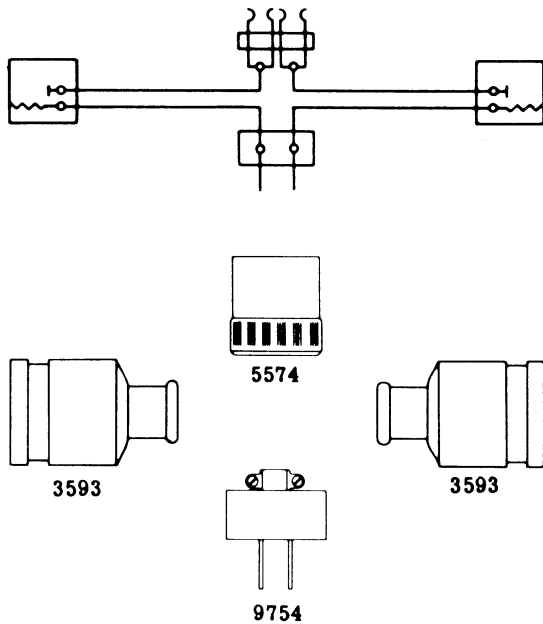

- (1) G. T. Co., Cord Assembly Consisting of:
 (2) 3593 Keyless Rubber Sockets (Hubbell)
 (1) 5574 Connector (Hubbell)
 (1) 9754 Plug (Hubbell)
 (2) 5 Amp. Plug Fuses (Buss)
 (4) W-2000 x 14 Stranded Wire (6 In. Long)
 (GTE AE)

(Replaced by 2PG4Z Cord Assembly)

2PG6V

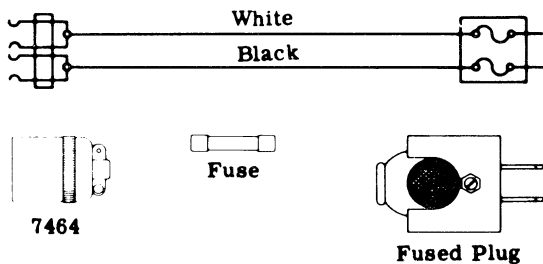

- (1) G. T. Co., Cord Assembly Consisting of:
 (1) 7464 Connector (Hubbell)
 (1) Fused Plug (Elmenco)
 (2) MDX Slow-Blowing 5 Amp. Fuses (Buss)
 (1) 8452 Rubber Jacketed Cord (10 Ft. Long)
 (Belden Mig. Co.)

2PG7V

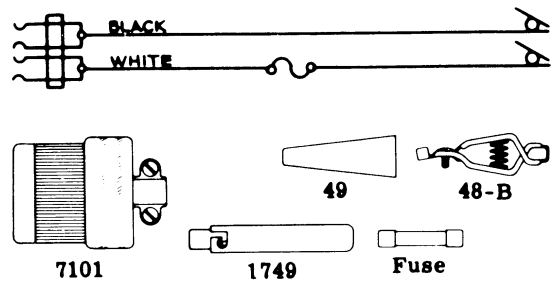

- (1) G. T. Co., Cord Assembly Consisting of:
 (1) 7101 Connector (Hubbell)
 (2) 48-B Clips (Mueller Elec. Co.)
 (2) 49 Insulators (Mueller Elec. Co.)
 (1) 3AG #311015 15 Amp. Fuse (Littlefuse)
 (1) 8452 Rubber Jacketed Cord (10 Ft. Long)
 (Belden Mfg. Co.)

2PG8Y

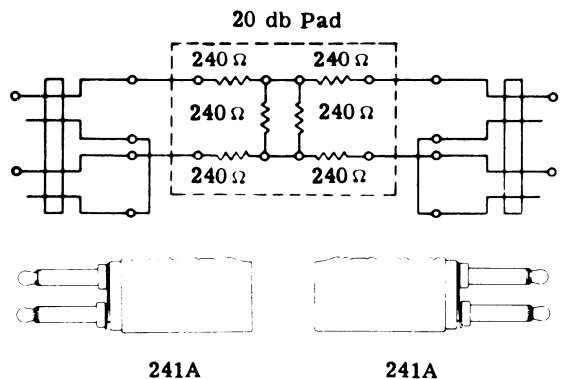

- (1) G. T. Co., Cord Assembly Consisting of:
 (2) 241A Plugs (Black Shells) (W. E. Co.)
 (1) 2700B Terminal Board or similar
 (Lerco Electronics Inc.)
 (6) 240 Ω \pm 5% Resistors (Ohmite)
 (1) P2AA Slate Cord (3 Ft. Long) (W. E. Co.)

2PG9Y

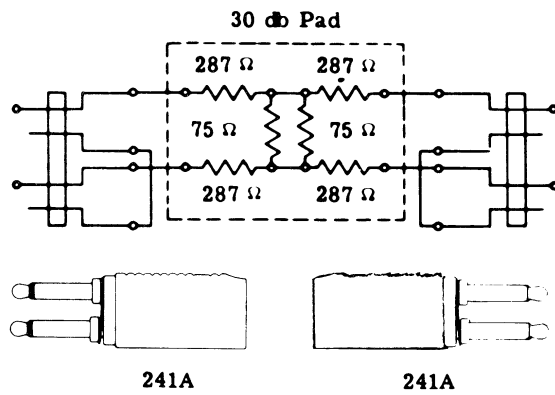

- (1) G. T. Co., Cord Assembly Consisting of:
- (2) 241A Plugs (Black Shells) (W. E. Co.)
- (1) 2700B Terminal Board or similar (Lerco Electronics Inc.)
- (4) RN20X2870F Series CVF 287 Ω ± 1% Resistors (Clarostat)
- (2) RN20X75ROF Series CVF 75 Ω ± 1% Resistors (Clarostat)
- (1) P2AA Slate Cord (3 Ft. Long) W. E. Co.)

2PG11W

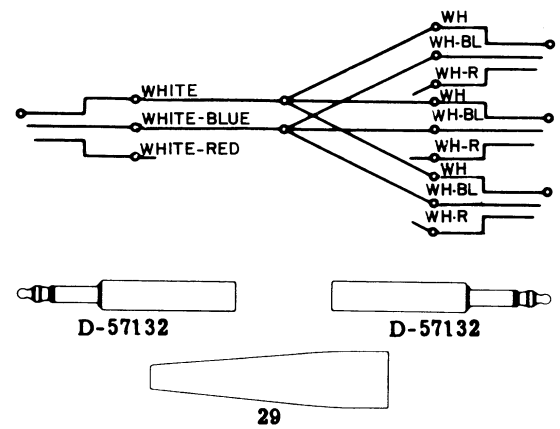

- (1) G. T. Co., Cord Assembly Consisting of:
 - (4) D-57132 Plugs (GTE AE)
 - (1) 29 Insulator (Mueller Elec. Co.)
 - (1) CD-406548RB Red Switchboard Cord (4 Ft. Long) (GTE AE)
 - (1) CD-406548GB Green Switchboard Cord (4 Ft. Long) (GTE AE)
- (Overall Cord Length is 8 Ft.)

2PG10W

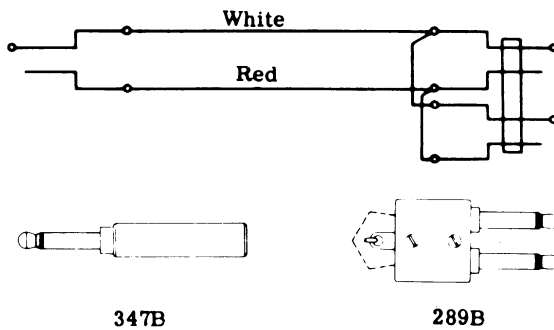

- (1) G. T. Co., Cord Assembly Consisting of:
- (1) 347B Plug (W. E. Co.)
- (1) 289B Plug (W. E. Co.)
- (1) P2AK Cord (8 Ft. Long) (W. E. Co.)

2PG12W

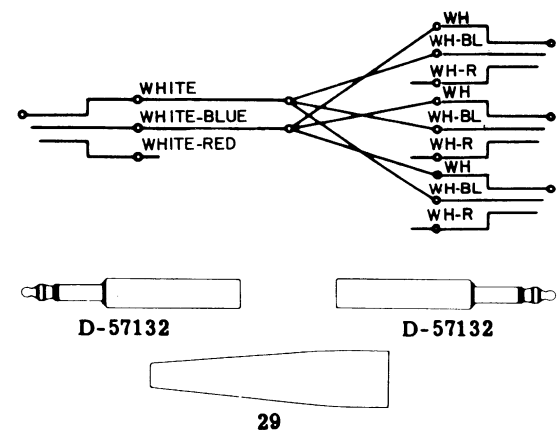

- (1) G. T. Co., Cord Assembly Consisting of:
 - (4) D-57132 Plugs (GTE AE)
 - (1) 29 Insulator (Mueller Elec. Co.)
 - (1) CD-406548RB Red Switchboard Cord (4 Ft. Long) (GTE AE)
 - (3) CD-406548GB Green Switchboard Cord (4 Ft. Long) (GTE AE)
- (Overall Cord Length is 8 Ft.)

2PG13W

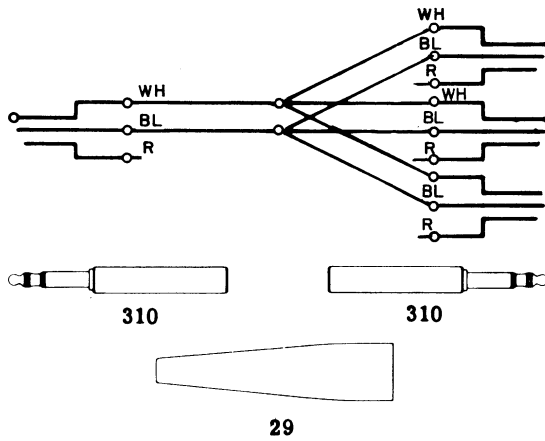

- (1) G. T. Co., Cord Assembly Consisting of:
- (4) 310 Plugs (Red Shells) (W. E. Co.)
- (1) 29 Insulator (Mueller Elec. Co.)
- (4) S3B Slate Switchboard Cords (4 Ft. Long) (W. E. Co.)

(Overall Cord Length is 8 Ft.)

2PG15X

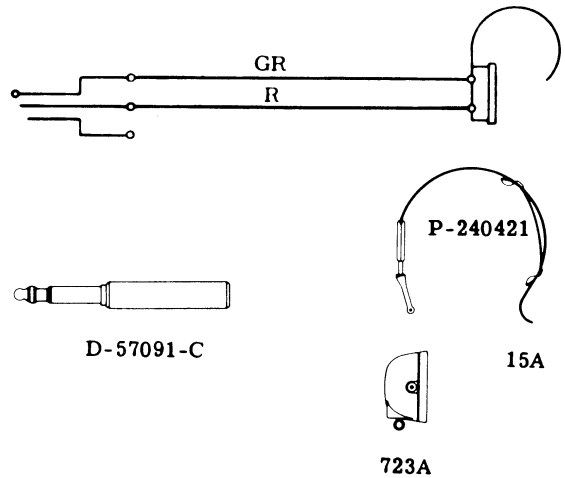

- (1) G. T. Co., Cord Assembly Consisting of:
- (1) D-57091-C Plug (GTE AE)
- (1) 15A Headband (W. E. Co.)
- (1) 723A Receiver Assembly (W. E. Co.)
- (1) P-240421 Rubber Pad (W. E. Co.)
- (1) R2CF Cord (6 Ft. Long) (W. E. Co.)

2PG14X

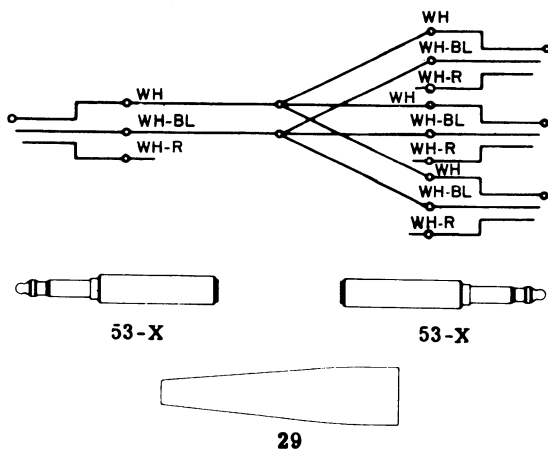

- (1) G. T. Co., Cord Assembly Consisting of:
- (4) 53-X Plugs (Stromberg Carlson)
- (1) 29 Insulator (Mueller Elec. Co.)
- (4) S-32-K Slate Switchboard Cords (4 Ft. Long) (Stromberg Carlson)

2PG16Y

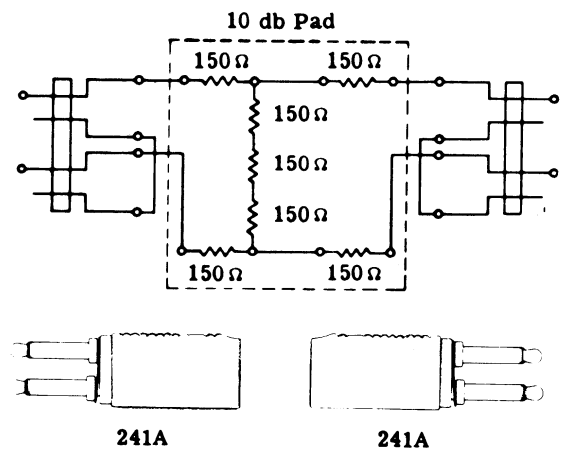

- (1) G. T. Co., Cord Assembly Consisting of:
- (2) 241A Plugs (Black Shells) (W. E. Co.)
- (1) 2700B Terminal Board or similar (Lerco Electronics Inc.)
- (7) 150 Ω \pm 10% Resistors (Ohmite)
- (1) P2AA Slate Cord (3 Ft. Long) (W. E. Co.)

2PG17X

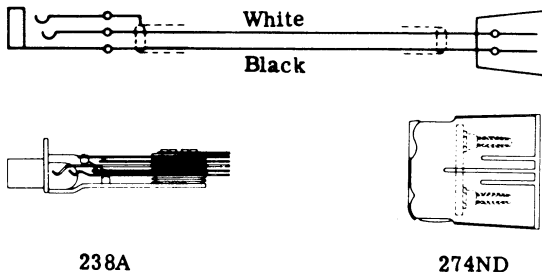

- (1) G. T. Co., Cord Assembly Consisting of:
 (1) 238A Jack (W. E. Co.)
 (1) 274ND Plug (General Radio Corp.)
 (1) P3P Slate Cord (6 Ft. Long) (W. E. Co.)

2W12A

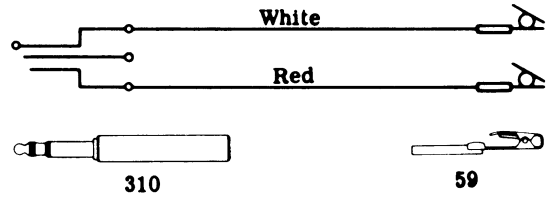

Res. .04Ω Per Ft.

- (1) W. E. Co., Cord Assembly Consisting of:
 (1) 310 Plug (Red)
 (2) 59 Cord Tips
 (1) W2M Black Cord (9 Ft. Long)

2W6A

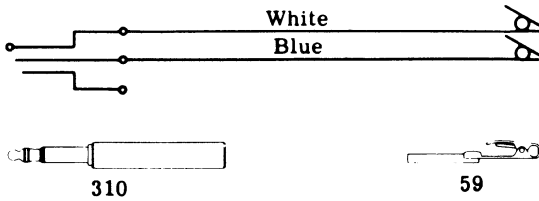

- (1) W. E. Co., Cord Assembly Consisting of:
 (1) 310 Plug (Red)
 (2) 59 Cord Tips
 (1) W2C Green Cord (10 Ft. Long)

2W15B

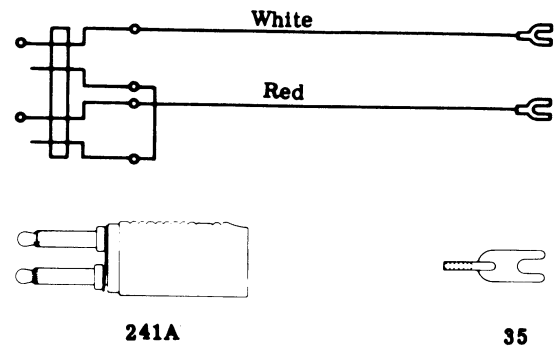

- (1) W. E. Co., Cord Assembly Consisting of:
 (1) 241A Plug (Black)
 (2) 35 Cord Tips
 (1) W2BP Green Cord (6 Ft. Long)

2W11A

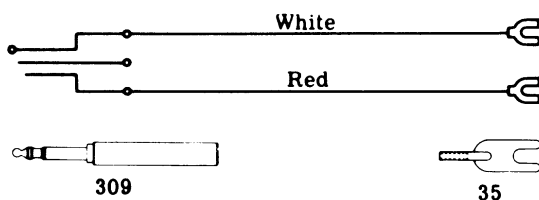

- (1) W. E. Co., Cord Assembly Consisting of:
 (1) 309 Plug (Red)
 (2) 35 Cord Tips
 (1) W2L Black Cord (5 Ft. Long)

2W17A

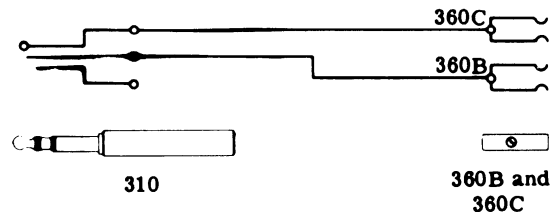

- (1) W. E. Co., Cord Assembly Consisting of:
 (1) 310 Plug (Red)
 (1) 360B Tool (Black)
 (1) 360C Tool (White)
 (1) W2W Slate Cord (6 Ft. Long)

2W17B

Same as 2W17A except cord is 30 ft. long.

2W17C

Same as 2W17A except cord is 10 ft. long.

2W21A

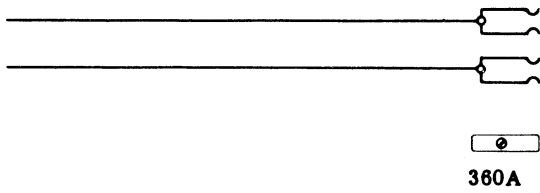

- (1) W. E. Co., Cord Assembly Consisting of:
 (2) 360A Tools (Red)
 (1) W2AB Brown Cord (6 Ft. Long)

2W24A

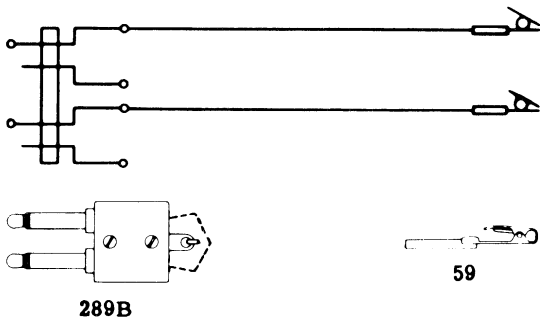

- (1) W. E. Co., Cord Assembly Consisting of:
 (1) 289B Plug (Black)
 (2) 59 Cord Tips
 (1) W2AY Green Cord (9-1/2 Ft. Long)

2W38A

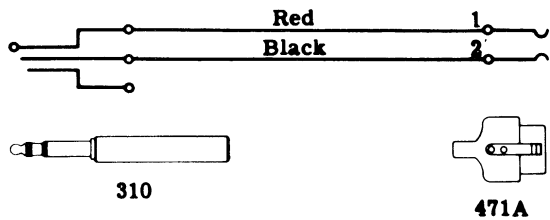

- (1) W. E. Co., Cord Assembly Consisting of:
 (1) 310 Plug (Red)
 (1) 471A Jack (Black)
 (1) W2CK Black Cord (5 Ft. Long)

2W42A

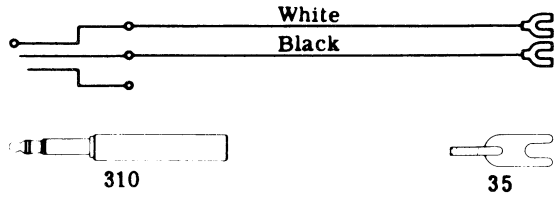

- (1) W. E. Co., Cord Assembly Consisting of:
 (1) 310 Plug
 (2) 35 Cord Tips
 (1) W2DL Black Cord (6 Ft. Long)

2WG1T (MFGR. DISC.)

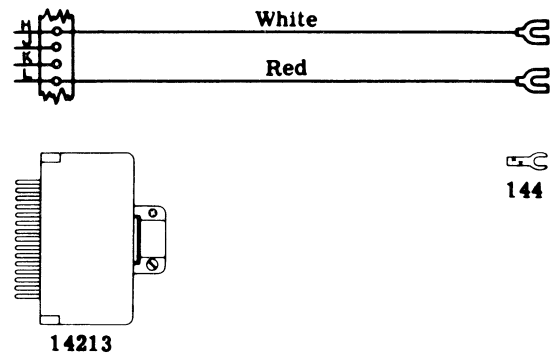

- (1) G. T. Co., Cord Assembly Consisting of:
 (1) 14213 CCT Plug-In-Cap (Cinch Mfg. Corp.)
 (2) 144 Spade Terminals (Whitney Blake)
 (1) P2J Black Cord (14 Ft. Long) (W. E. Co.)

(Replaced by 2WG10W Cord Assembly)

2WG2Y

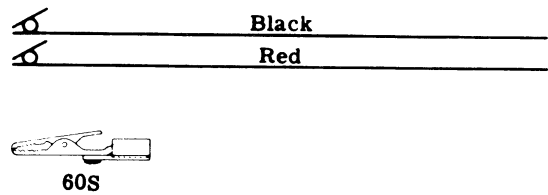

- (1) G. T. Co., Cord Assembly Consisting of:
 (2) 60S Alligator Clips (Mueller Elec. Co.)
 (2) 8899 Wires (4 Ft. Long) (Belden Mfg. Co.)

2WG3V

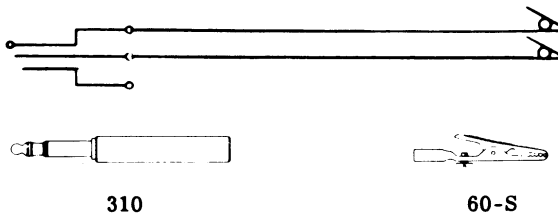

- (1) G. T. Co., Cord Assembly Consisting of:
- (1) 310 Plug (W. E. Co.)
- (2) 60S Alligator Clips (Mueller Elec. Co.)
- (1) 2 Conductor Cord (10 Ft. Long)

2WG5X

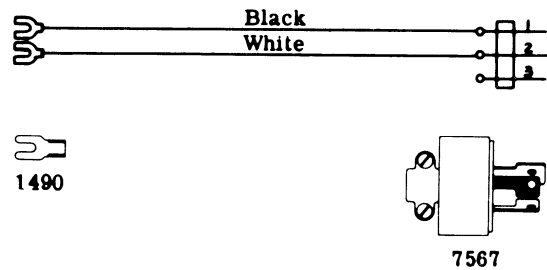

- (1) G. T. Co., Cord Assembly Consisting of:
- (2) 1490 Spade Tips (Herman A. Smith, Inc.)
- (1) 7567 Twist-Lock Plug (Hubbell)
- (1) 8022 Retractable Cord (6 Ft. Long When Extended) (Koled Kord)

2WG4V

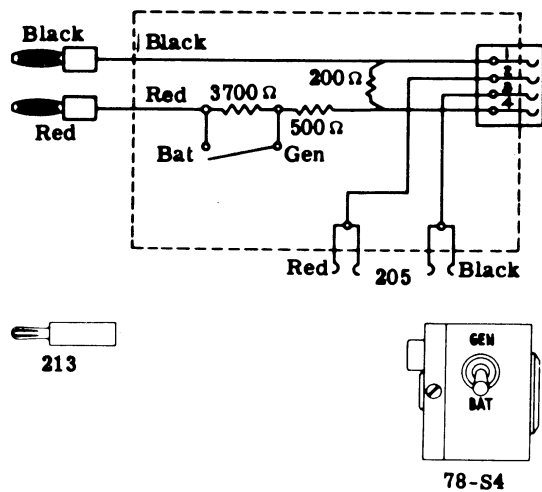

- (1) G. T. Co., Cord Assembly Consisting of:
- (2) 213 Banana Plugs (Herman A. Smith, Inc.)
- (2) 205 Banana Jacks (Cinch-Jones, Inc.)
- (1) 78-S4 Socket (Amphenol)
- (1) 1135 S. P. S. T. Bat. Lever Toggle Switch 3 Amp. 125 Volt (Spemco)
- (1) M-54 Cabinet (Cal Chassis)
- (1) 10 Watt 200 Ω Resistor (Ohmite)
- (1) 10 Watt 500 Ω Resistor (Ohmite)
- (1) 10 Watt 3700 Ω Resistor (Ohmite)
- (2) 8899 Wires (10 Ft. Long) (Belden Mfg. Co.)

2WG6X

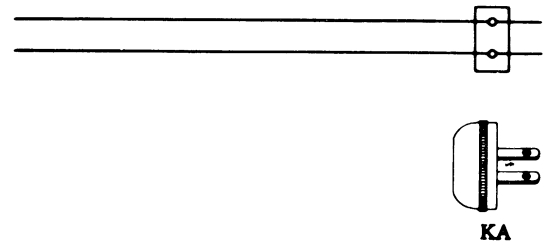

- (1) G. T. Co., Cord Assembly Consisting of:
- (1) KA Plug (Bryant Elec. Co.)
- (1) Type Pos. J-32 Rubber Ripcord (6 Ft. Long) (G. E. Co.)

2WG7X

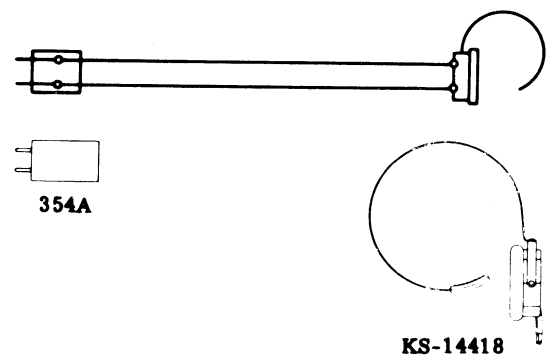

- (1) G. T. Co., Cord Assembly Consisting of:
- (1) 354A Plug (W. E. Co.)
- (1) 2 Conductor Cord (5 Ft. Long)
- (1) KS-14418 Headset (Brush Development)

2WG8X

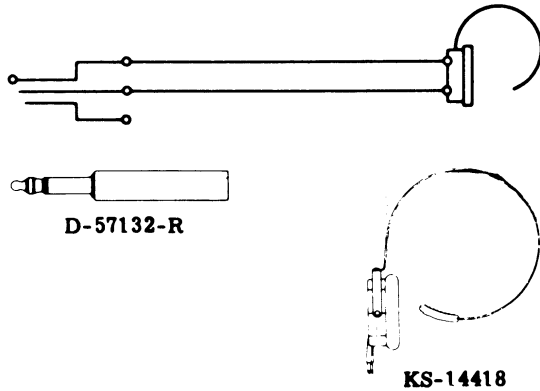

- (1) G. T. Co., Cord Assembly Consisting of:
- (1) D-57132-R Plug (GTE AE)
 - (1) KS-14418 Headset (Brush Development)
 - (1) 2 Conductor Cord (5 Ft. Long)

2WG10W

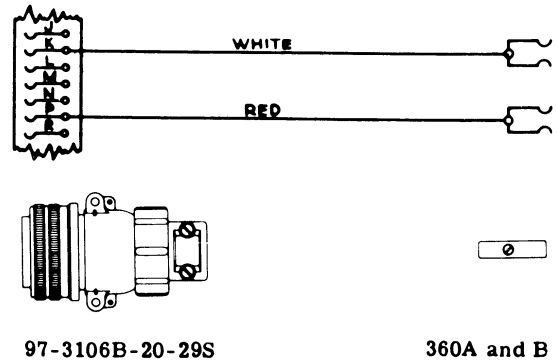

- (1) G. T. Co., Cord Assembly Consisting of:
- (1) 97-3106B-20-29S Plug (Amphenol)
 - (1) AN-3057-12 Cable Clamp (Amphenol)
 - (1) 360A Tool (Red) (W. E. Co.)
 - (1) 360B Tool (Black) (W. E. Co.)
 - (1) P2J Cord (9 Ft. Long) (W. E. Co.)

2WG9V

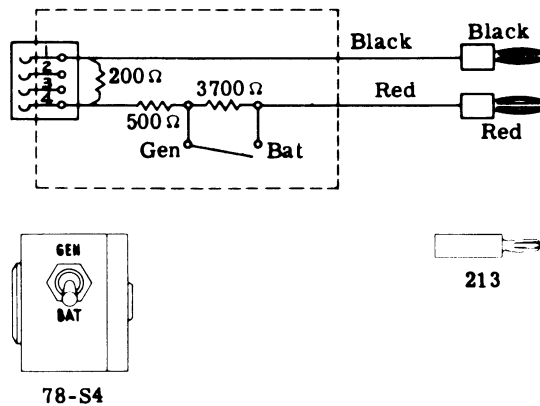

- (1) G. T. Co., Cord Assembly Consisting of:
- (1) 78-S4 Socket (Amphenol)
 - (2) 213 Banana Plugs (Herman A. Smith, Inc.)
 - (1) 1135 S. P. S. T. Bat. Lever Toggle Switch 3 Amp. 125 Volt (Spemco)
 - (1) M-51 Cabinet (Cal Chassis)
 - (1) 7036 Rubber Grommet (Walsco)
 - (1) 10 Watt 200 Ω Resistor (Ohmite)
 - (1) 10 Watt 500 Ω Resistor (Ohmite)
 - (1) 10 Watt 3700 Ω Resistor (Ohmite)
 - (2) 8899 Wires (10 Ft. Long) (Belden Mfg. Co.)

2WG11L

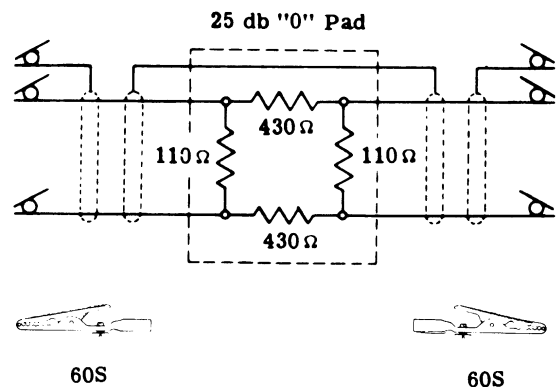

- (1) G. T. Co., Cord Assembly Consisting of:
- (6) 60S Alligator Clips (Mueller Elec. Co.)
 - (1) 2700B Terminal Board or similar (Lerco Electronics Inc.)
 - (2) 110 $\Omega \pm 5\%$ Resistors (Ohmite)
 - (2) 430 $\Omega \pm 5\%$ Resistors (Ohmite)
 - (1) 8422 Microphone Cable (30 Ft. Long) (Belden Mfg. Co.)

(Shield Used as an Additional Conductor.)

2WG12X

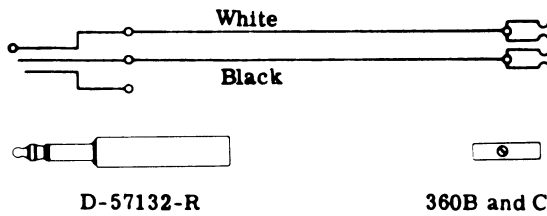

- (1) G. T. Co., Cord Assembly Consisting of:
 (1) D-57132-R Plug (GTE AE)
 (1) 360B Tool (Black) (W. E. Co.)
 (1) 360C Tool (White) (W. E. Co.)
 (1) W2W Slate Cord (6 Ft. Long) (W. E. Co.)

KS-5785 List 3

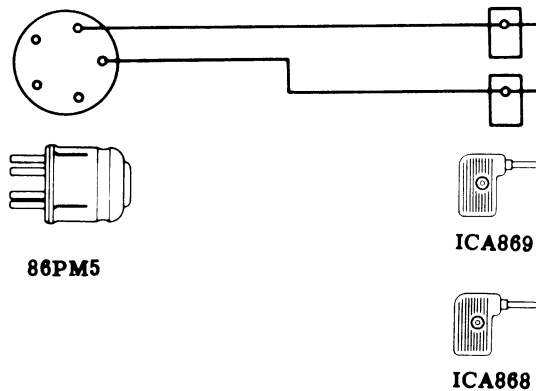

- (1) W. E. Co., Cord Assembly Consisting of:
 (1) 86PM5 Cable Connector (Amphenol)
 (1) 869 Elbow Tip (Black) (I. C. A.)
 (1) 868 Elbow Tip (Red) (I. C. A.)
 (1) Pos 64 Cord (3 Ft. Long)

L2Y

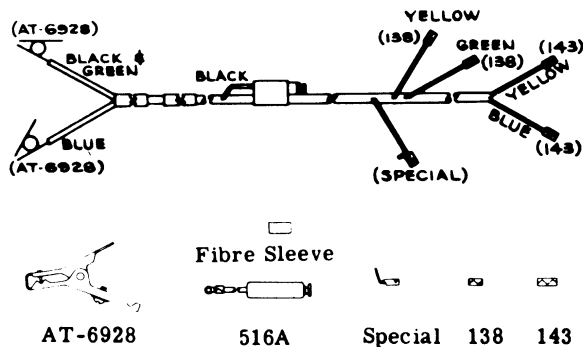

- (1) W. E. Co., Cord Assembly Consisting of:
 (2) AT-6928 Test Clips
 (2) Fibre Sleeves
 (1) 516A Capacitor
 (2) 138 Cord Tips
 (2) 143 Cord Tips
 (1) Special Cord Tip
 (1) Two Conductor Black Cord (7 Ft. Long)

W2BL

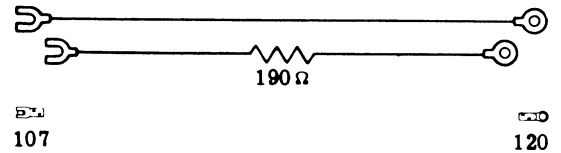

- (1) W. E. Co., Cord Assembly Consisting of:
 (2) 107 Cord Tips
 (2) 120 Cord Tips
 (1) 2 Conductor (Black) Cord (10 Ft. 4 In. Long)

W2CB

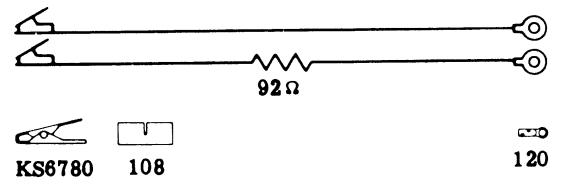

- (1) W. E. Co., Cord Assembly Consisting of:
 (2) KS6780 Clips
 (2) 108 Cord Tips
 (2) 120 Cord Tips
 (1) 2 Conductor Brown Cord (10 Ft. 4 In. Long)

W2CW

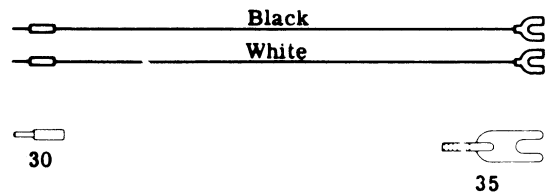

- (1) W. E. Co., Cord Assembly Consisting of:
 (2) 30 Cord Tips
 (2) 35 Cord Tips
 (1) 2 Conductor Black Cord (6 Ft. Long)