

**SB6610B 5-Line Key System**

**Issue 3**

Contents	PAGE
1.0 GENERAL	1
2.0 SPECIFICATIONS	1
3.0 INSPECTION	3
4.0 MOUNTING	3
5.0 INSTALLER CONNECTIONS	3
6.0 CIRCUIT DESCRIPTION	6
7.0 TESTING	6

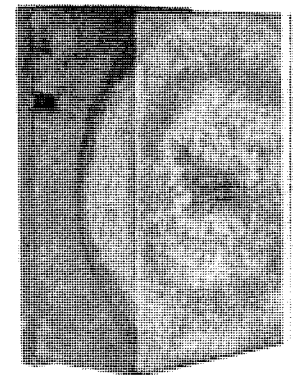
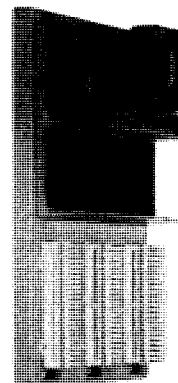

**SB6610B KEY TELEPHONE SYSTEM**

**FIGURE 1**

**1.0 GENERAL**

1.1 This section provides general description and installation instructions for the SAN/BAR SB6610B Key Telephone System - Issue 3.

The SB6610B KTS consists of a basic pre-wired mounting fixture (for wall mounting) which will mount a variety of plug-in circuit cards, and a power supply assembly. The system is designed to provide a means of connection to a maximum of five Central Office lines and also has one mounting slot for several special functions.

1.2 The SB6610B may be equipped to provide such features as music-on-hold, PA coupler, Manual Intercom, Off-Premises extension, FM music source, and Dial-Intercom.

The SB6610B is provided with three quick connect distribution blocks as shown in Figure 1 for all wiring interfacing to the Central Office and local distribution.

1.3 The power supply assembly (shown in Figure 2) mounts at the top of the SB6610B and is held in place with snap fasteners for quick installation or replacement. All distribution wiring between

the power supply and the rest of the SB6610B assembly is by a keyed locking connector assembly assuring proper interconnect wiring. The power supply assembly may be provided with interrupter and/or ringing generator as options. The power supply and ringing generator are U.L. recognized assemblies.

1.4 The SB6610B is wall mounted; mounting is easily accomplished by one installer. A keyhole is located at the top center of the assembly to initially mount the unit, and mounting holes are located on each side of the center terminal block at the bottom to secure the assembly to the wall. Each unit is provided with a cover.

**2.0 SPECIFICATIONS**

2.1 List of Applicable Drawings:

a. Assembly Drawing

Chassis: ED-6610-200 (Fig. 6)

Power Supply: ED-6610-301/306 (Fig. 7)

Ring Generator: ED-6610-401 (Fig. 8)

b. Bill of Materials

Chassis: BM-6610-200

Power Supply: BM-6610-301/306

RinginG Generator: BM-6610/401

c. Schematic Diagrams

System: WD-6610-200 (Fig. 4)

Power Supply: SD-6610-301 (Fig. 5)

RinginG Generator: SD-6610-401 (Fig. 5)

2.2 Electrical Characteristics

a. 5 CO or PBX Lines

b. One special feature connector is provided for options such as the SB6609B Dial Intercom, SB423A Manual Intercom, or SB4201A FM Receiver.

c. Input Power: 90 to 130 VAC, 60 Hz.

d. Available Voltages:

24VDC: A-Battery (AC Ripple suitable for Talk Battery) 0.7A

18VAC: (Buzzers) 1 amp continuous, 4 amps intermittent.

10VAC: (Lamps) 1 amp continuous, 4 amps intermittent.

105VAC; 30 HZ: (Ringers) 50 ma nominal.

e. Fuses:

110VAC Input - 2A.

10/18VAC Output - 5A.

24VDC Output, 105VAC ringinG are self limiting and are not fused.

f. Operating Environment: 0° to 50°C, Humidity to 90%.

g. Lamp Flash: Flashing visual signal on incoming calls.

h. Station Audible or Common Audible: 18VAC for buzzers or optional 105VAC, 30 HZ for ringers.

i. Line Busy Indication: Steady lamp signal during line busy conditions.

j. Hold Function: Individual holding of calls on any line.

k. Lamp Wink: Winking visual signal during hold condition.

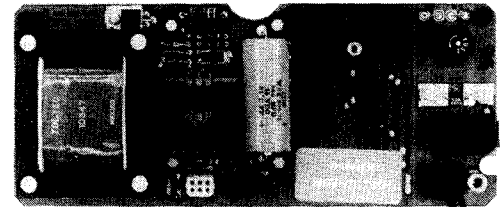

SB6610B-301 BASIC SUPPLY

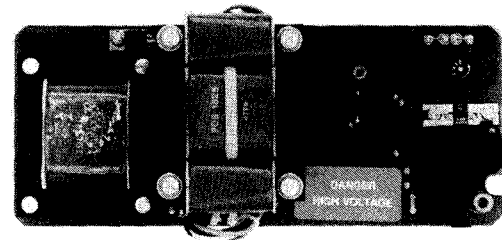

SB6610B-306 SUPPLY WITH RINGING GENERATOR

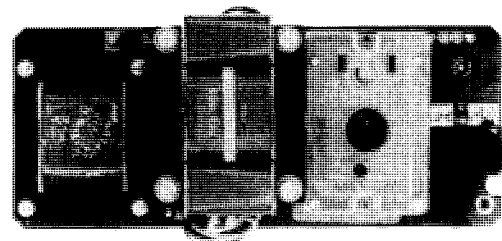

SB6610B-306 SUPPLY WITH INTERRUPTER

FIGURE 2. POWER SUPPLY OPTIONS

2.3 Physical Characteristics

a. Overall Dimensions (including cover) 9.8" W x 15" H x 7" D.

b. Wall Mounting Holds: 3 mounting holes are provided with 1/4 inch clearance holes for the mounting hardware. The maximum O.D. for washers used should be 3/4" or less.

c. Rear Access: Rear access is normally not required. The power supply is mounted from the front and all normal wiring is available from the front.

d. Weight: Approximately 13 lbs. with power supply. (Not including circuit cards).

e. Component Connectors (power unit): A quick-connect connector is provided for ease of installation of the power unit, with prewired harness for the chassis.

f. Interrupter Mounting: Plug-in connector is prewired for installation of the mechanical interrupter provided by SAN/BAR as part number POR-3010-000A.

## 2.4 KTS Circuit Cards

### a. SB4000F KTU LINE CARD -

Specially designed circuitry and solid state components eliminate high voltage transient failures and prevent false ring-in through line induced AC voltages or remote two-wire telephone instrument dialing. Design guarantees that 200 milliseconds of ringing signal will trigger the ring-in circuitry, and also provides protection against drop-out of hold during battery reversal.

Equipped with a light emitting diode to indicate busy or idle line condition. Also available with circuitry that protects against false "Dial-1 transfer" with a strap option for 500ms Delayed Hold Release.

### b. SB4100A KTU LINE CARD FOR OFF-PREMISES EXTENSIONS -

A complete KTU line circuit with the additional circuitry required to permit duplication of key-set features and supervision at remote locations to provide off-premises extension service with one control pair. Provides means for two, or more, connected stations to completely control a telephone circuit. One unit required at each location. Loop limits 1800 ohms.

### c. SB4200A MUSIC-ON-HOLD CARD -

Provides KTU Line Card, Music-On-Hold and Bell System Interconnect interface (LOH), (STC) functions all on one 18-pin circuit card. With these built-in features, installation consists only of connecting of two leads from the music source to two points on the KTU mounting shelf. No other auxiliary devices or wiring is required. The built-in LOH specification circuitry provides DC isolation, amplitude limiting at -12 dbm and at least 85 dbm cross-talk attenuation. Equipped with LED to indicate busy or idle condition.

### d. SB4201 FM RECEIVER FOR MUSIC-ON-HOLD -

A complete music source designed to be used in conjunction with SB4200A KTU line cards to provide music-on-hold service. One SB4201A is normally sufficient to provide service for an entire installation. Receiver is mounted on a 18-pin KTU line card-sized circuit board which inserts in any KTU line card position. Music is transmitted from the SB4201A to SB4200A line cards on pins 3 and 18 via common straps in the KSU.

### e. SB423A MANUAL INTERCOM-

Standard KTS manual intercom similar to WECO 401. Manufactured to SAN/BAR's strict quality control for long, trouble-free service.

### f. SB6609B SINGLE LINK INTERCOM

Single link intercom providing intercommunications between 10 stations of a key telephone system. The basic unit SB6609B is rotary dial and the model SB6609B-100 contains a tone converter so that both rotary dial and touch-tone phones may be intermixed within the intercom system. The basic SB6609B intercom is field expansable to include the touchtone converter by ordering the SB6609B-101 assembly.

## 3.0 INSPECTION

Inspect the unit thoroughly as soon as possible after delivery. Visually inspect for broken and loose wires, or chassis damage. If any part of the unit has been damaged in transit, report the extent of damage to the transportation company immediately.

## 4.0 MOUNTING

The SB6610B is designed for wall mounting and should be mounted firmly to a suitable back-board as required. Three mounting holes are provided for use with 1/4" lag bolts or wood screws. Clearance is provided for up to 3/4" O.D. washers. Locate the desired position for the KTS and mark the top-center keyhole location.

NOTE: The KTS may be mounted as close as desired to adjacent equipment or ceiling. No clearance for the hinging of the cover is required.

Screw the KTS to the wall with the one top mounting hole, then locate the two lower mounting holes.

## 5.0 INSTALLER CONNECTIONS

The SB6610B KTS is factory wired and requires only minimal amount of installer wiring for most installations. A prewired connector allows the power supply to be quickly installed. All normal user functions appear at the three feature blocks located on the chassis. Figures 4 & 5 show the basic wiring for the system and power unit.

## 5.1 Feature Block Connections

Line cards and special feature cards plug into the 6 standard 18-pin connectors. The required functions appear for distribution at the appropriate locations of the feature blocks.

Card positions 1 thru 5 are wired for standard line cards (such as the SB4000F or WECO 400D). Position 6 is wired primarily for the SB6609B Intercom, but may be adapted to other special features.

a. For card positions 1 thru 5, all wiring is per conventional practice with the following exceptions. Pins 3 and 18 appear individually at the feature blocks (rather than bussed) for use on special function cards. Pin 10 is wired for interrupted 18VAC for buzzers. Pin 11 is wired for interrupted 105VAC for ringers. Therefore either interrupted buzzer or ringing can be chosen for common audible by strap option on the line card. For buzzers, option-T. For ringers, option-W.

b. Each of the three feature blocks is wired for two circuit card connections as shown below. Figure 3 gives the function as they appear at the blocks.

TB-A (upper)	Pos. 1
TB-A (lower)	Pos. 2
TB-B (upper)	Pos. 3
TB-B (lower)	Pos. 4
TB-C (upper)	Pos. 5
TB-C (lower)	Pos. 6

c. Table 1 below defines the possible usage of each of the card positions for the most common usage functions. Follow the circuit descriptions of the individual cards for detailed installation instructions:

Table 1

Card Function	SAN/BAR Card Type Number	SB6610B Card Slot Assignment
1. Line Card	SB4000F	1-5
2. Off Premises Extension Line Card	SB4100A	1-5
3. Music On Hold Line Card	SB4200A	1-5
4. Music Source (FM Tuner)	SB4201A	1-6
5. Manual Intercom	SB423A	1-6
6. Single Link Dial Intercom	SB6609B	6 only

d. Cable routing to the feature blocks is up through two cut-outs in the bottom of the KTS cover. Cut-outs in the chassis for securing the cable with "ty-wraps" have been provided. Do not route any wires along the outer edge of the chassis that will interfere with the KTS cover.

## 5.2 POWER SUPPLY INSTALLATION

### a. SB6610B-301/306 Power Supply

The power supply is installed in the upper part of the chassis, and held in place by snapping in the two locking plungers. Connection is made to the system through a keyed female connector J7 on the power supply and mating male connector P7. Route the power supply cord through either the left or right cut-outs provided in the cover. (Using the left cut-out may require that the cord lay over the top of the ring generator.) The line cord is then plugged into the 117V, 60Hz AC supply.

NOTE: Although the chassis and positive battery are grounded through the AC line cord, there is the possibility of lightning damage due to a voltage difference to true earth ground. It is therefore recommended that connection be made to a good ground, such as a main cold water pipe, to binding post E1. The largest wire that E1 will accept is 12 AWG.

### b. SB6610B-300/305 Power Supply

The mounting chassis for the new issue KTS has also been revised to add support braces in the power supply mounting space. If it is desired to mount a previous issue power supply (-300/305) these supports must be removed. This is easily accomplished with a pair of wire cutters.

### c. SB6610B-401 Ringing Generator

This section only applies for field installation of a ringing generator in the SB6610-301 power supply. (The SB6610-306 power supply is equipped with the ringing generator mounted in place).

Disconnect the line cord from the AC supply and remove power supply from the chassis. Mount the ringing generator assembly on the front-side of the supply, using the four unused holes on the mounting plate. Orient the generator assembly so that the connector is positioned over J10 of the power supply. Use the four screws provided.

#### d. Interrupter

To install the interrupter the power supply does not have to be removed from the chassis. Simply plug the interrupter into J8, and secure it by tightening the captive screw.

#### e. Bell/Buzzer Option for Intercom

A U-link strap option is provided on the power supply so that either 105VAC (bell) or 18VAC (buzzer) will appear at J6, the intercom card position. Set U-link as follows:

- 18VAC — Option A (factory set)
- 105VAC — Option B

The 18/105VAC option also appears at TBA for external use (see figure 4).

### 5.3 INTERCOM INSTALLATION

#### a. SB6609A 10-Station Intercom

Install the SB6609A in position 6 of the KTS only. Select the audible signaling (18 VAC/105 VAC) as specified in Sections 5.2e. Refer to figure 3 for function assignment at the feature block. NOTE: Audible common RG is the same as Lamp Ground (LG). Terminate the buzzer or bell returns to spare RG to LG terminals as required. Refer to CD-6609-000 for more details.

#### b. SB6607A-800 Touch-Tone Adapter

Install the SB6607A-800 in position 5 on the KTS only. Remove the X1, X2, X3 straps located on the circuit board. Make the following connections at the feature blocks; (a) Line 5 - Jumper COT to OPT2, jumper COR to OPT1, (b) Jumper line 5-T to line 6-R. Refer to CD-6607-800 for more details.

#### c. SB6609B 10 Station Intercom

Install the SB6609B in position 6 of the KTS only. Select the audible signaling (18VAC/105VAC) as specified in section 5.2e. Refer to Fig. 3 for function assignment at the feature block TBC. NOTE: Audible common RG is the same as lamp ground (LG). Terminate the buzzer or ringer returns to spare RB or LG terminals as required. Refer to the SB6609B circuit description for additional details.

#### d. SB423 Manual Intercom

May be installed in any line card position 1 thru 6. Talk battery to the card must be jumpered at

the feature blocks. Jumper (at the appropriate line position) AG to 3, AB to 18 as shown in Fig. 3. 18VAC appears at TBA as described in section 5.2e, if required for customer provided buzzer signaling. Refer to CD-0423-000 for more details.

#### e. Intercom Feature Block Straps - TBC

The strap for the SB6609A or SB6609B 10 station intercom is factory strapped. Remove the strap and restrap the feature block if the SB423A manual intercom or other feature is used in position 6.

<u>Assembly</u>	<u>From</u>	<u>To</u>
SB6609A/B	TBC-2B	TBC-13C
SB423A	TBC-2B	TBC-11B
	TBC-2C	TBC-11C
	TBC-13A	TBC-13C

### 5.4 MUSIC-ON-HOLD INSTALLATION

#### a. SB4200A Line Cards

The SB4200A cards may be installed in position 1 thru 5. The music source is distributed via pins 3 and 18. Jumper together all pin 3's and all pin 18's at the appropriate feature block positions involved.

Connect the music source (if externally provided to any of the pins 3 and 18 terminals. Refer to CD-4200-000 for more details.

#### b. SB4201A FM Receiver

If using the SB4201A, install in any spare position 1 thru 6. Jumper (at the feature block) pins 3 and 18 to the rest of the music distribution as described above. If using position 6 for the SB4201A, the pins 3 and 18 are labeled Sig-1 and 2 respectively (refer to figure 3). External antenna connections are brought into the feature block to COT, COR (Sig-0 and 5 in position 6).

NOTE: If using AE line cards for music-on-hold, connect together all the pin 3's of each position including the SB4201A. Leave pin 18 open at each line position. Jumper AG to 18 at the SB4201A position.

### 5.5 COVER MOUNTING

The cover for the KTS secures to the chassis by snap-in tabs. The cover does not require any additional clearance from the ceiling or adjacent

equipment. To mount the cover, first insert the two top mounting tabs. Secure the cover by inserting the two lower (outside) tabs and then snapping the locking tab (lower-middle) into place. To remove, press up on the locking tab and the cover will come off easily.

## 6.0 CIRCUIT DESCRIPTION

Please refer to the schematic drawings Figures 4 & 5 for the following descriptions.

### 6.1 SB6610B-301 Power Supply

117VAC is applied to the primary winding (Blk-Blk) of transformer T1. The transformer has two secondary windings. One winding is tapped to provide 10 and 18VAC which provides the lamp and buzzer output voltages. The other winding has an output of 32 VAC which is full-wave rectified by diode bridge CR1-CR4 to produce 40VDC across capacitor C1. Transistors Q1 and Q2, together with Zener diode CR5, form a pre-regulator which keeps a constant 30VDC across the input of VR1. VR1 is an integrated voltage regulator which maintains a constant 24VDC at its output. VR1 is internally current limited, so no output fusing is necessary.

### 6.2 SB6610B-401 Ringing Generator

AC line voltage appears across the split primary windings and associated network of T2. Because of the diode CR1, much more current flows in one direction than the other, causing the secondary voltage to have a heavy 30 Hz component. Capacitor C1 and the secondary winding are resonant at 30 Hz, so that the output voltage across T2-4 and T2-3 will be an approximate sine wave, with a fundamental frequency of 30 Hz.

### 6.3 Interrupter

When AC common is applied to the interrupter on the ST lead, the motor will run. 10VAC, 18VAC and 105VAC are interrupted by cam-driven contacts to provide Lamp Wink, Lamp Flash, Interrupted Buzzer and Ringing voltages.

## 7.0 TESTING

### 7.1 Key Telephone System

If trouble is encountered with the SB6610B Key Telephone System, check that all installer connections or strap options have been made properly. Refer to the individual circuit card descriptions for test of the units. The KTS fixture contains no electrical components that are

normally considered subject to failure. However, possible wire breakage or poor wire terminations may be verified using normal continuity checking procedures with a standard multimeter (Simpson 263 or equivalent).

### 7.2 Power Supply Assembly

If the system difficulties is determined to be related to the power unit, make sure that the system power requirements have not exceeded the power supply rating specified in section 2.0. Make sure that the installer connections are made properly. Verify that the connector is mating properly. If trouble persists, verify that all power supply voltage outputs are present using a standard multimeter. Refer to the schematic diagrams for locating where the outputs appear. (NOTE: It may be necessary to remove the power supply from the KTS to verify the problem if it is due to shorts in the system.

7.3 If it has been determined that there has been a card, chassis, or power failure; do not attempt to make field replacement of electrical parts. The SB6610B is warranted for a period of 2 years from date of purchase.

Return unit to:

SAN/BAR Corporation  
17422 Pullman St.  
P.O. Box 11787  
Santa Ana, CA 92711

For Technical assistance call  
(714) 546-6500

# TB - A/B

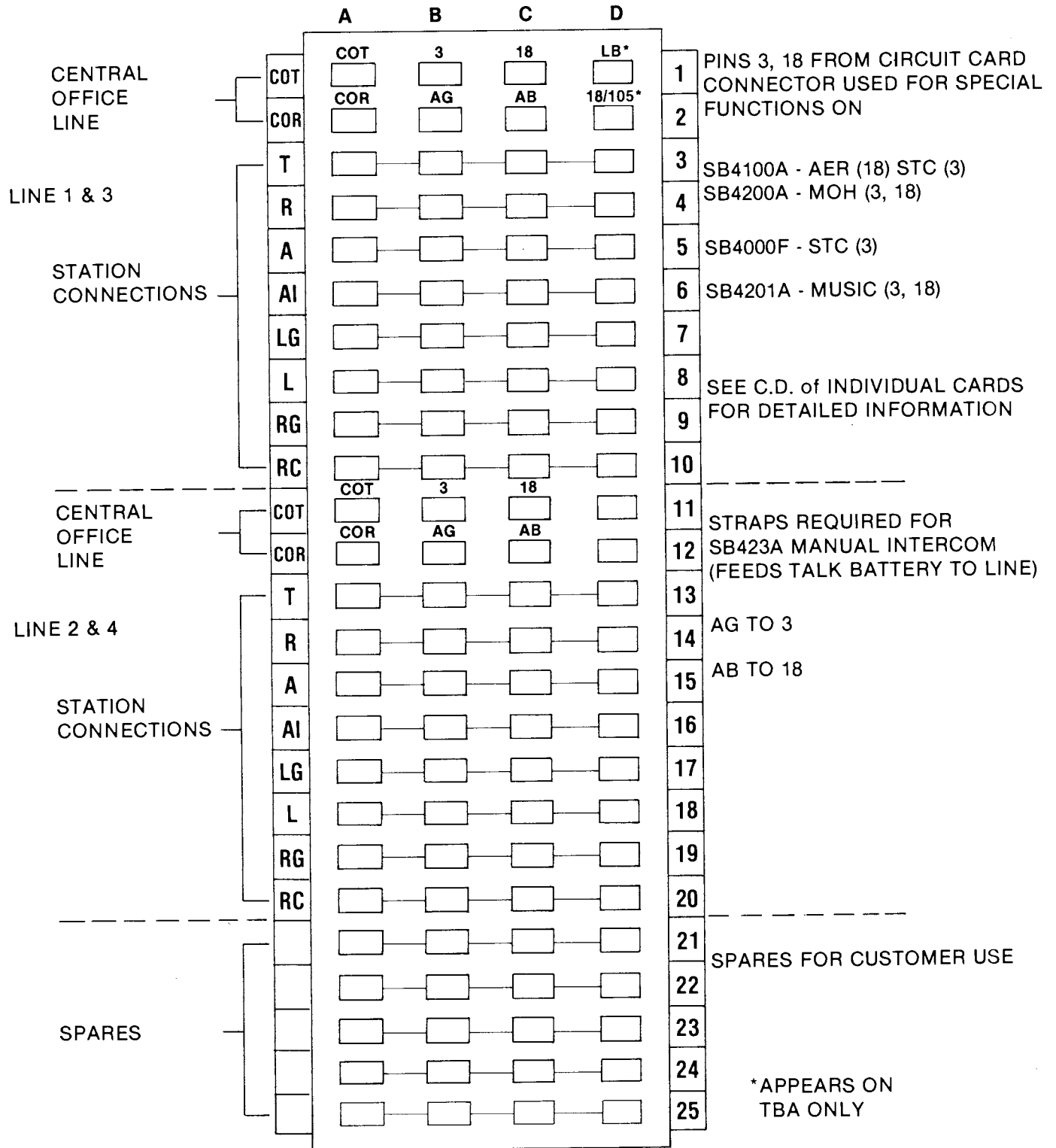

FEATURE BLOCK CONNECTIONS  
FIGURE 3A

\* APPEARS ON  
TBA ONLY

# TB-C

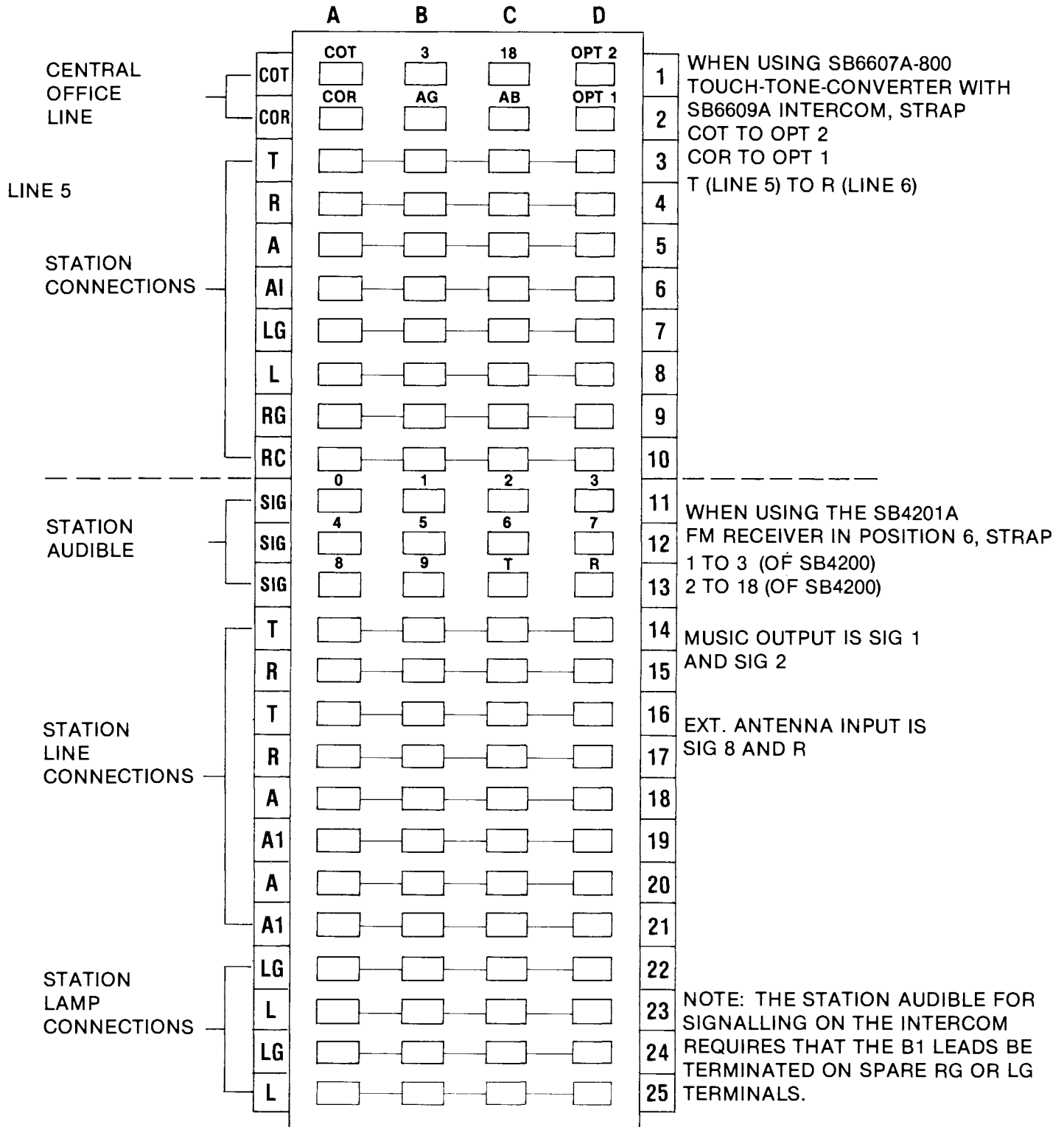

FEATURE BLOCK CONNECTIONS  
FIGURE 3B



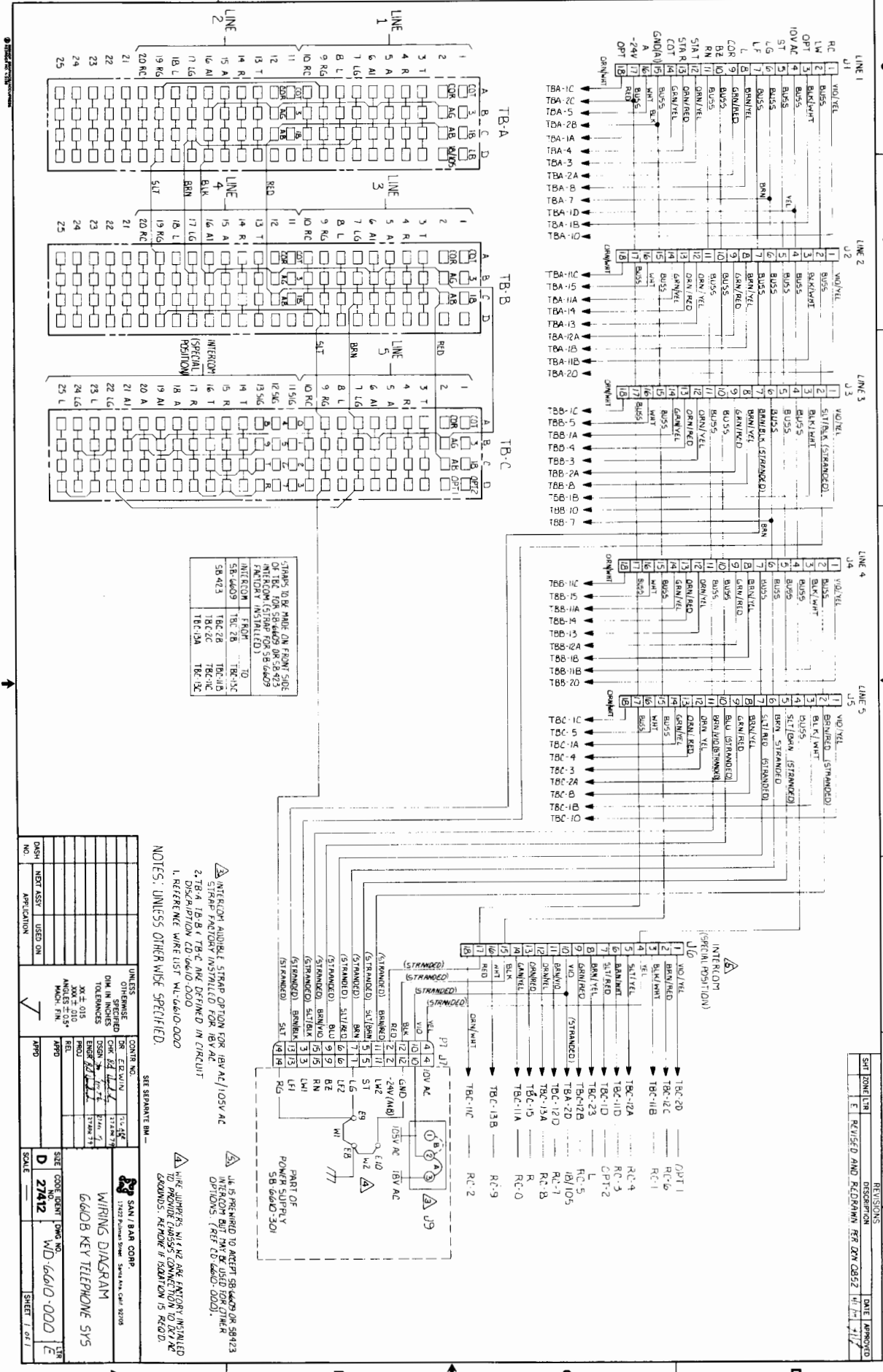

STARS TO BE MADE ON FRONT SIDE OF TR. FOR 5B-6409 OR 5B-6423	TR-10C	TR-10C
INTERCOM (SPECIAL POSITION)	TR-10C	TR-10C
5B-6409	TR-2B	TR-10C
5B-6423	TR-2C	TR-10C
	TR-10A	TR-10C

NO.	DASH	REVISIONS	DATE APPROVED
		1	
		2	
		3	
		4	
		5	
		6	
		7	
		8	
		9	
		10	
		11	
		12	
		13	
		14	
		15	
		16	
		17	
		18	
		19	
		20	
		21	
		22	
		23	
		24	
		25	

UNLESS OTHERWISE SPECIFIED, ALL DIMENSIONS ARE IN INCHES.

WIRING DIAGRAM

660B KEY TELEPHONE SYS

WD-6610-000

SCALE

SEE SEPARATE BM.

WIRING DIAGRAM

660B KEY TELEPHONE SYS

WD-6610-000

SCALE

NOTES: UNLESS OTHERWISE SPECIFIED.

1. REFER TO WIRE LIST FOR WIRE TYPES AND COLORS.

2. TR-A, TR-B, & TR-C ARE DEFINED IN CIRCUIT DISPOSITION CD 6610-000.

3. WIRE NUMBERS WITH AN X ARE FACTORY INSTALLED TO PROVIDE CHASSIS CONNECTION TO EXT. EQUIPMENT. REMOVE IF DISAPPOINTED IS REQUIRED.

4. IT IS REQUIRED TO ADJUST 5B-6409 OR 5B-6423 FROM FACTORY SETTING TO PROVIDE CORRECT OPERATING CONDITIONS. (REF. CD 6610-000).

WIRE TYPES AND COLORS:

1	2	3	4	5	6	7	8	9	10
11	12	13	14	15	16	17	18	19	20
21	22	23	24	25					

FIGURE 4

REVISIONS					
SHT	ZONE	LTR	DESCRIPTION	DATE	APPROVED
A			RELEASE PER DCN 0721	1967	

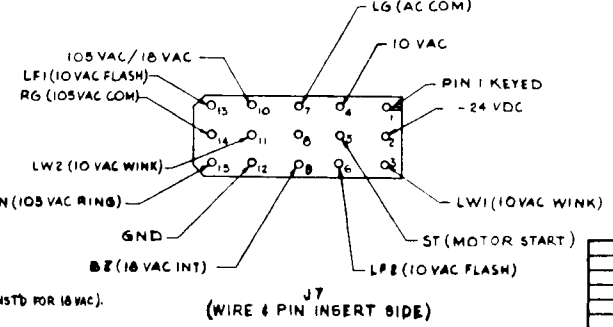
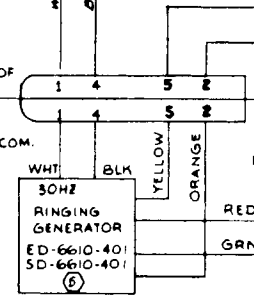
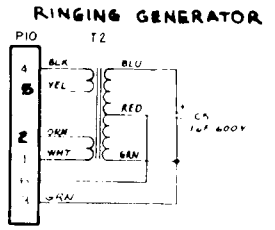
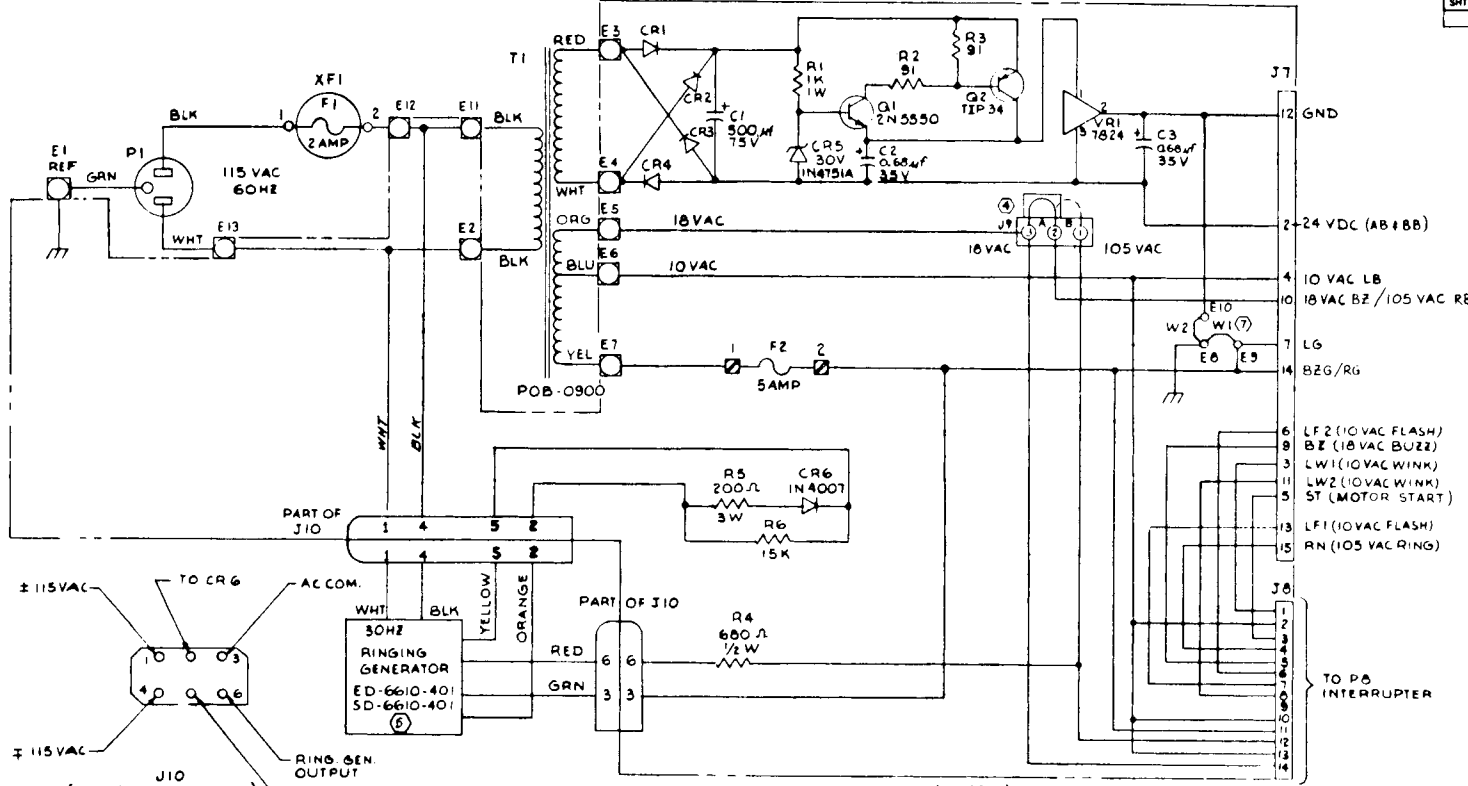

- ⑦ WIRE JUMPERS W1 & W2 ARE FACTORY INSTALLED TO PROVIDE CHASSIS CONNECTION TO DC & AC GNDS. REMOVE IF ISOLATION REQUIRED.
  - ⑧ ALL RESISTORS 1/4 W, 1%.
  - ⑤ REF ED-6610-306 FOR ASSY. OF RINGING GENERATOR TO POWER SUPPLY (FACTORY PROVIDED FOR SB6610B-306 ONLY).
  - ④ P1 LINK MAY BE INSTALLED FOR EITHER 10 VAC, 'A' POSITION; OR 105 VAC, 'B' POSITION, INTERCOM REQUIREMENTS. (FACTORY INSTD FOR 10 VAC).
  - 3. DIODES ARE IN 4002.
  - 2. INSTALL WIRES PER WIRE LIST WL-6610-301
  - 1. ALL PARTS ASSEMBLED TO ED-6610-301
- NOTES: UNLESS OTHERWISE SPECIFIED

UNLESS OTHERWISE SPECIFIED DIM. IN INCHES TOLERANCES		CONTR NO		SAN I BAR CORP	
ASSEMBLY	ED-6610-301	DR CONT	10-3-77	17422 Mulliken Street Santa Ana Calif 92710	
DRAWING	ED-6610-301	CHK		SCHEMATIC 6610B	
ENG		DESIGN		60HZ POWER SUPPLY	
APP		PROJ		SIZE D	
DASH NO		REL		CODE 27412	DWG NO SD-6610-301
		APP		SCALE NONE	LTR A
					SHEET 1 OF 1

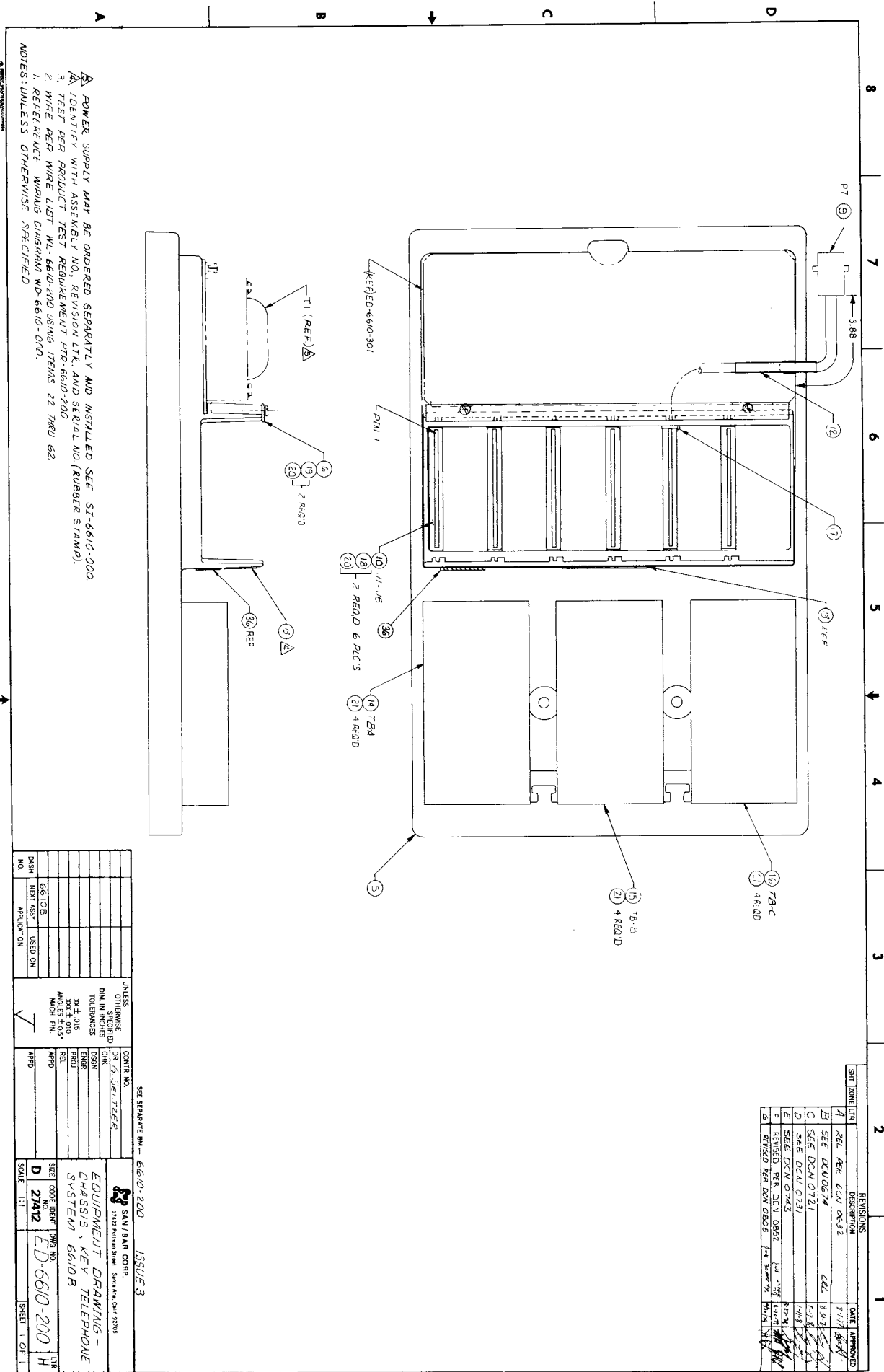

POWER SUPPLY MAY BE ORDERED SEPARATELY AND INSTALLED SEE SI-6610-000 IDENTIFY WITH ASSEMBLY NO., REVISION LTR., AND SERIAL NO. (RUBBER STAMP).

TEST PER PRODUCT TEST REQUIREMENT PTR-6610-700

WIRE PER WIRE LIST WL-6610-200 USING ITEMS 22 THRU 82.

REFERENCES: WIRING DIAGRAM WD-6610-CMN.

NOTES: UNLESS OTHERWISE SPECIFIED

DASH NO.		SECTION		USED ON		APPROVATION		UNLESS OTHERWISE SPECIFIED		CONT'G NO.		DATE APPROVED	
NO.	MOD.	NO.	ASSY.	NO.	APPROVATION	NO.	APPROVATION	DATE	BY	NO.	DATE	BY	DATE

SEE SEPARATE BM - 6610-800

ISSUE 3

EQUIPMENT DRAWING - CHASSIS, KEY TELEPHONE SYSTEM 6610B

SCALE: 1:1

SHEET 1 OF 1

REV	DATE	BY	DESCRIPTION
1	11/11/66	...	REL. REV. LCU 0632
2	8-27-66	...	SEE DCU 0634
3	1-18-66	...	SEE DCN 0721
4	1-18-66	...	SEE DCN 0731
5	8-27-66	...	SEE DCN 0743
6	1-18-66	...	REVISED PER DCN 0892
7	1-18-66	...	REVISED PER DCN 0902

FIGURE 6

Figure 8

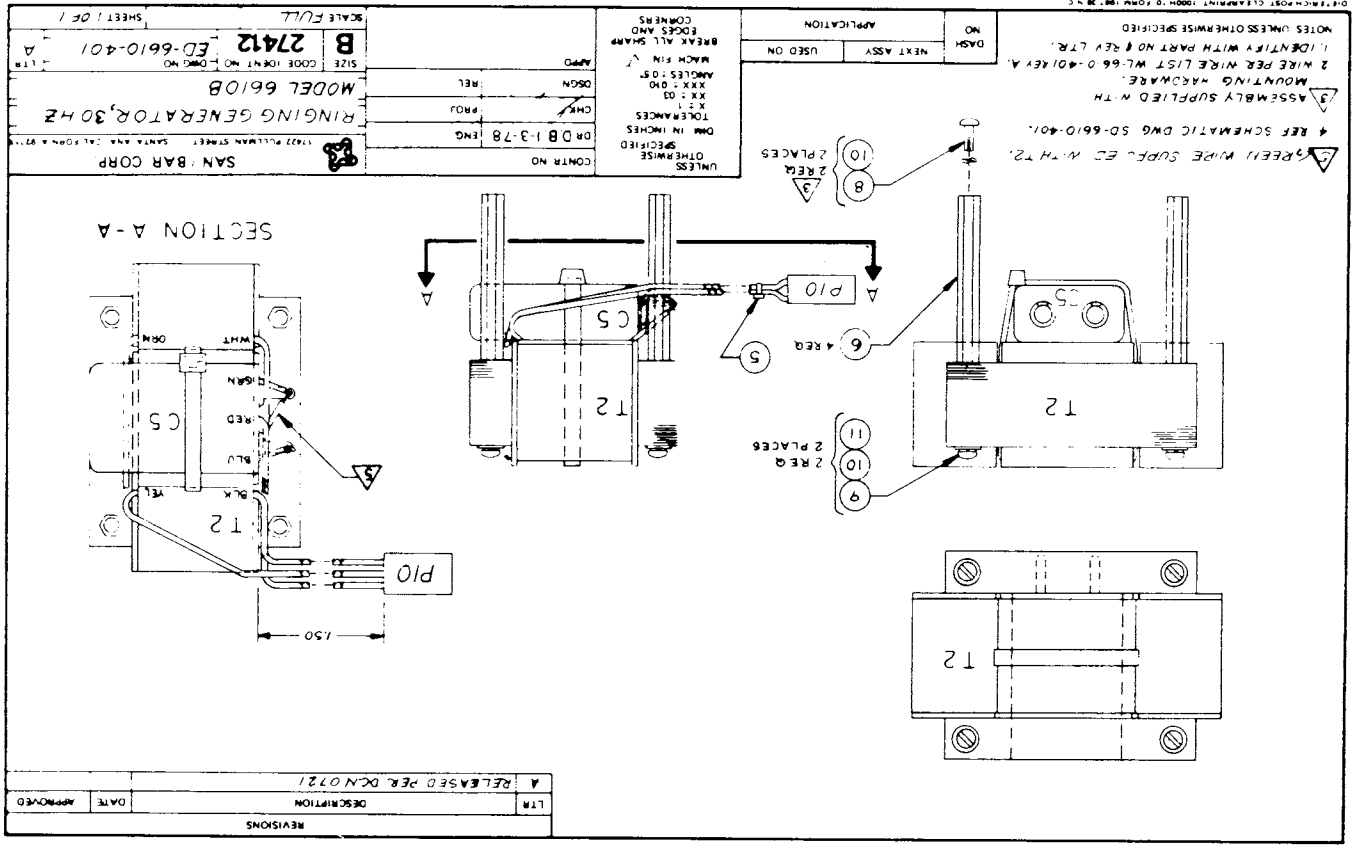

Figure 7

