

**FIG 1A**  
FUSE ALARM

**FIG 2**  
RELEASE ALARM  
1 PER SELECTOR

**FIG 3**  
BATTERY JACKS  
1 PER PABX

**FIG 4**  
RING START  
1 PER PABX

**FIG 5.**  
LINE START  
1 PER PABX

**FIG 6**  
PULSE START  
1 PER PABX

**FIG 7**  
DIAL TONE  
DISTRIBUTION  
1 PER PABX

**FIG 8**  
BUSY TONE  
DISTRIBUTION  
1 PER PABX

**FIG 9.**  
RING TONE  
DISTRIBUTION  
1 PER PABX

**FIG 10**  
WARN TONE  
DISTRIBUTION  
1 PER PABX

- NOTES**
- 1 ORDER OF CIRCUITS IN WIRING RUN READ FROM TOP TO BOTTOM
  - 2 EXCEPT WHERE OTHERWISE STATED ALL WIRING BEARING A COLOUR CODE TO BE 0.6 mm
  - 3 UNLESS OTHERWISE SPECIFIED, TAGS ARE ON MISC STRIP CONN
  - 4 GBW NUMBERS IN BRACKETS REFER TO EQUIPMENTS MANUFACTURED TO SPECIFICATIONS OS 1035 & OS 1050 BRACKETS WITH NO NUMBER INDICATE THAT THE CONNECTION DOES NOT EXIST ON THESE EARLY EQUIPMENTS

**NZ NOTE**  
A WHEN EXTENSION 89 IS A DISTANT EXTENSION VIA A CARRIER SYSTEM, CONNECT Fb & NE 22 WIRES TO INT RING & INT RING RET

**EXPLANATORY**  
PART OF MISC CCTS  
GBW 14700 (13250) OR EQUIV

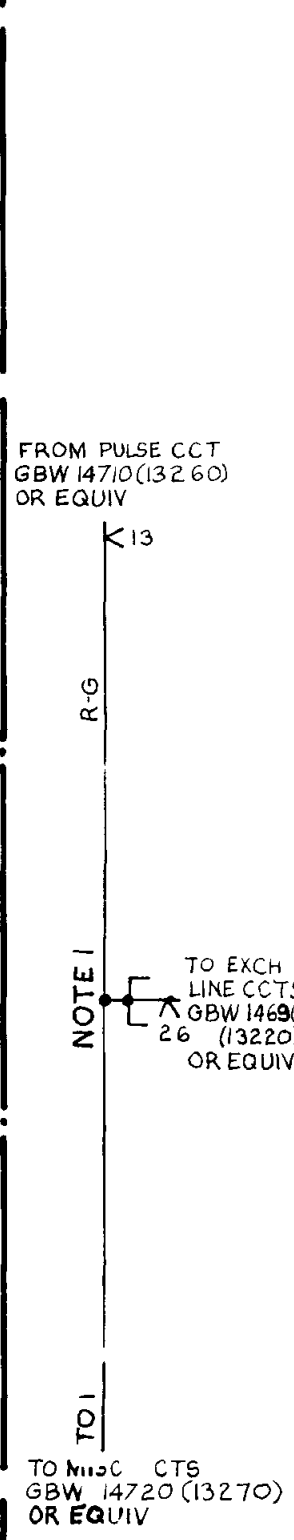
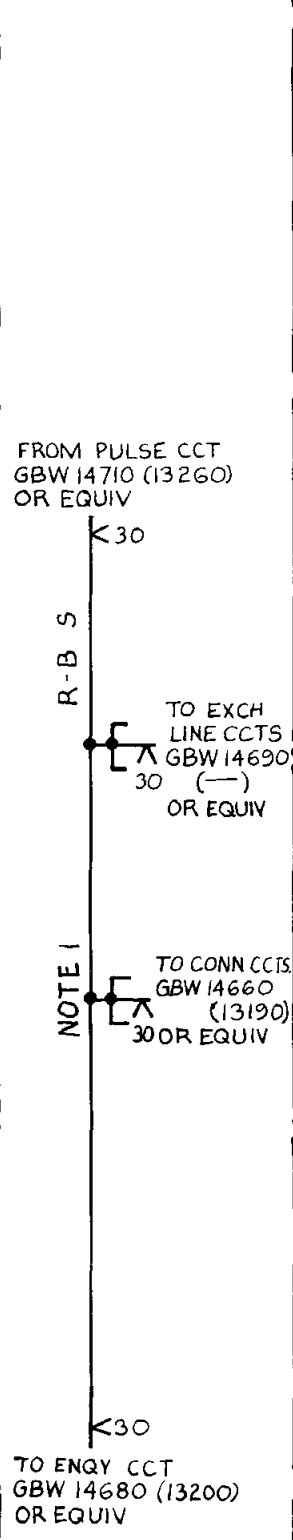
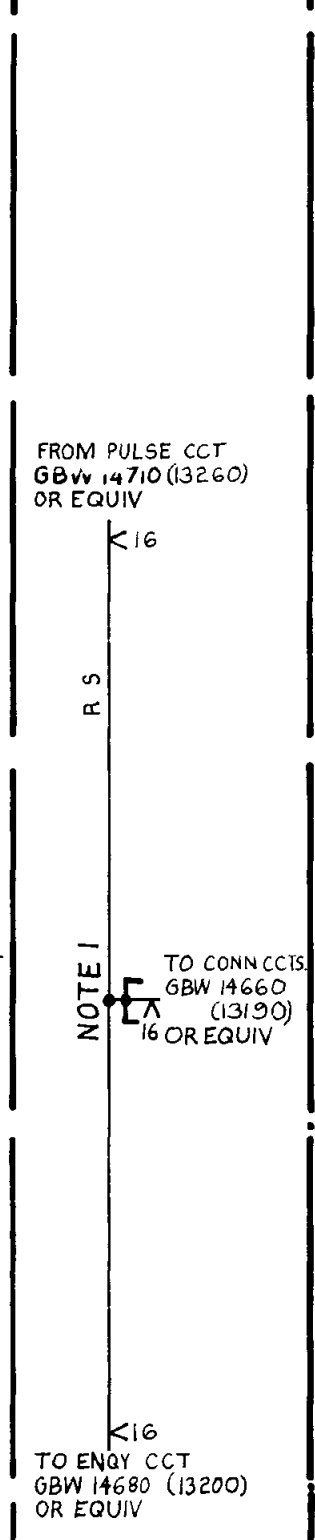
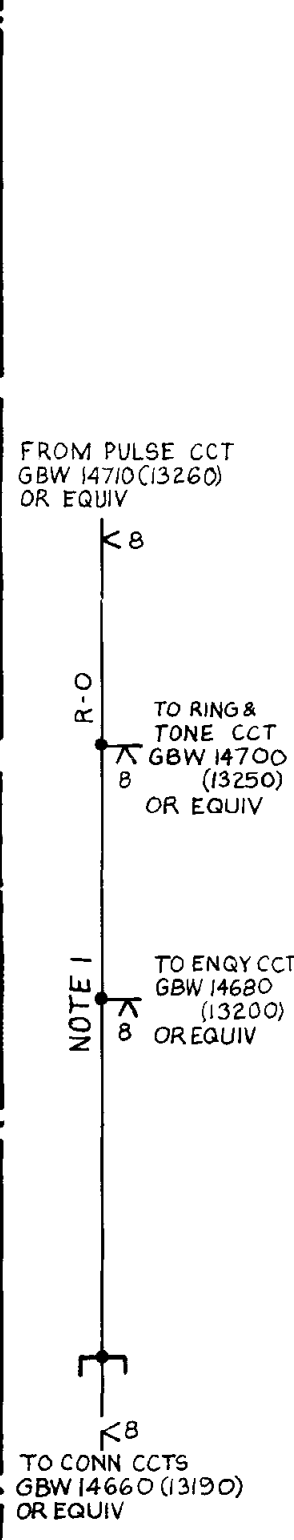
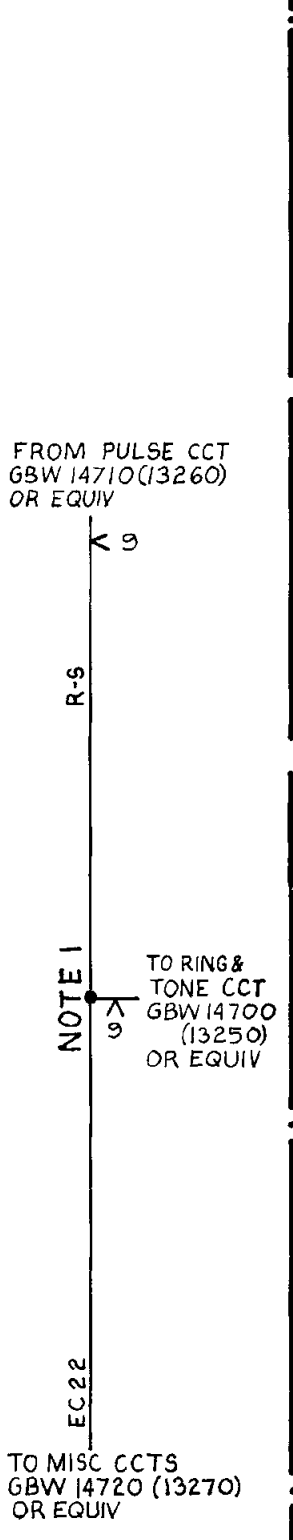
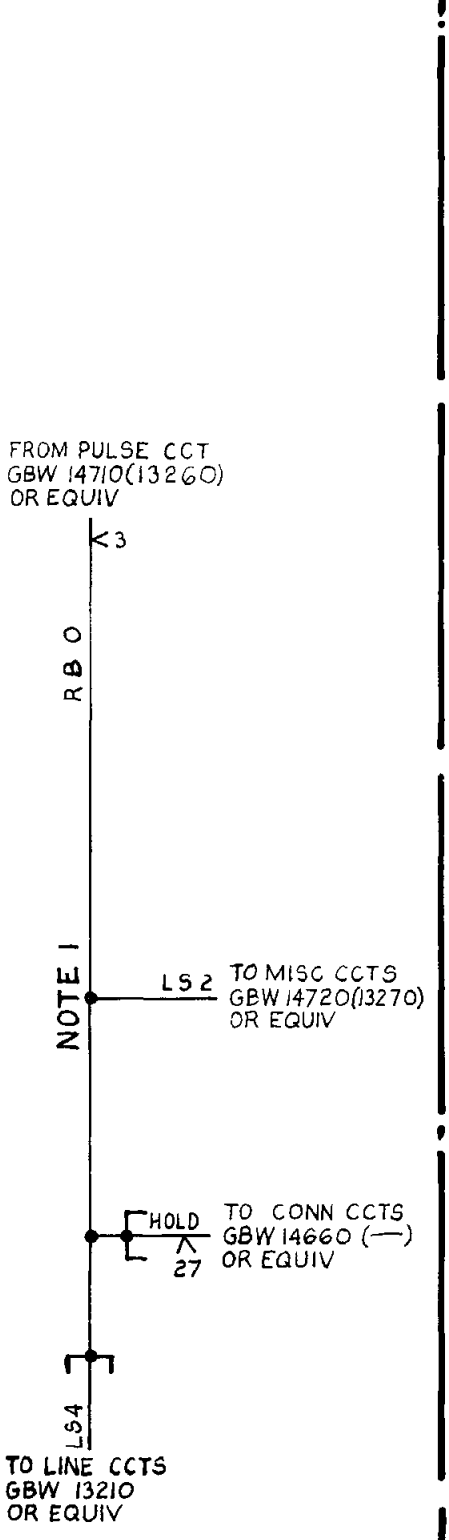
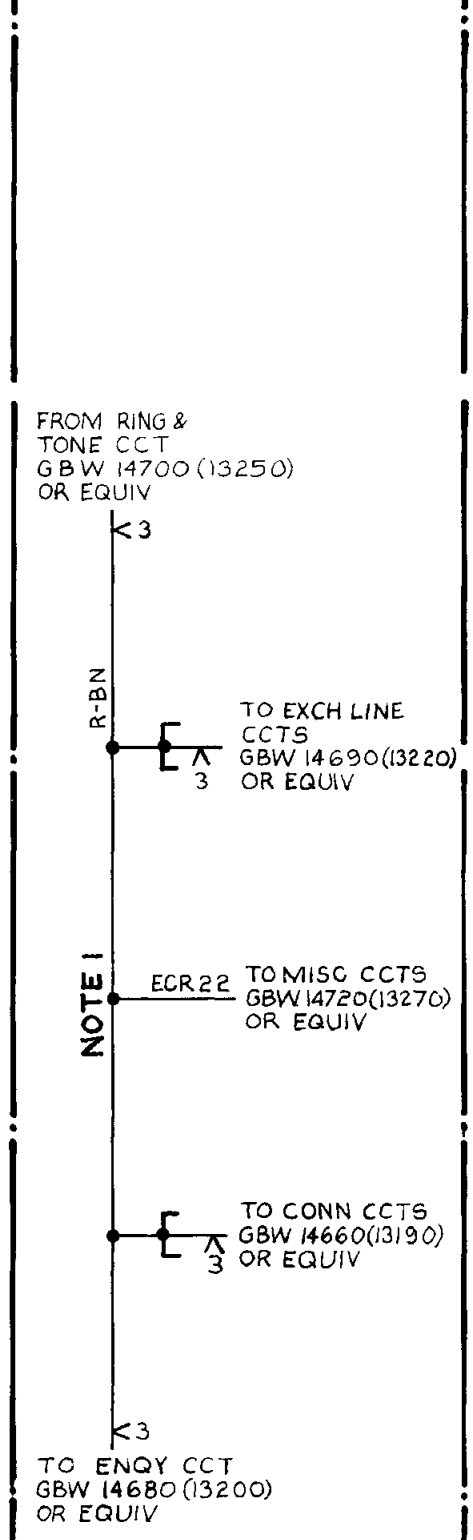
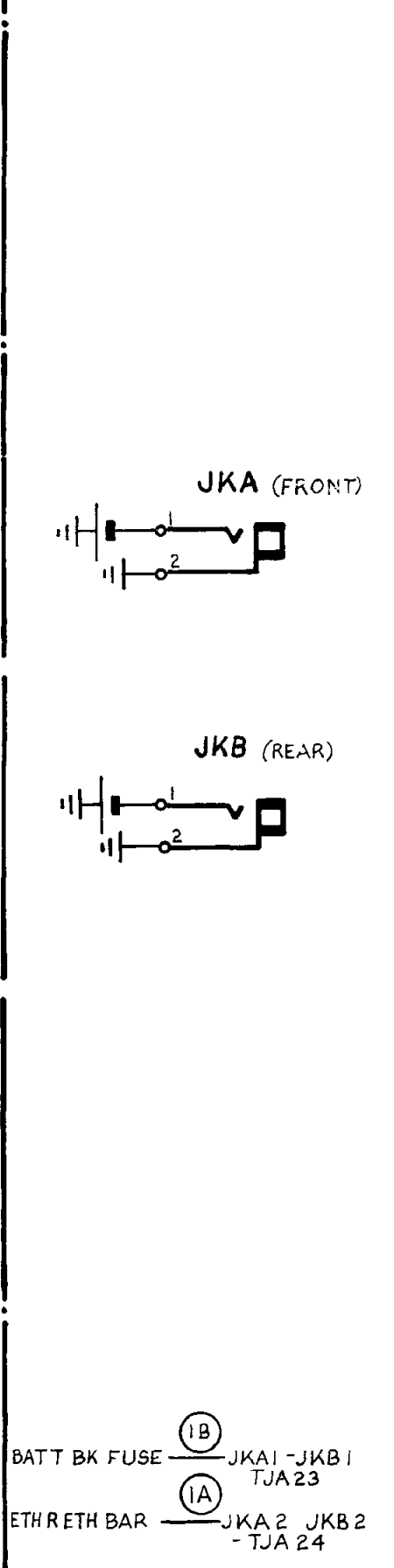
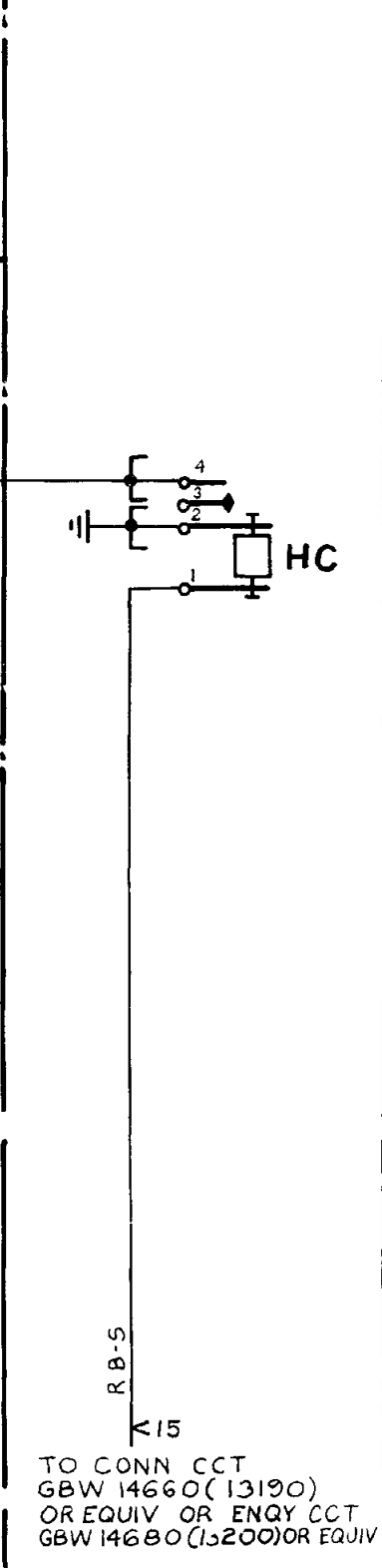
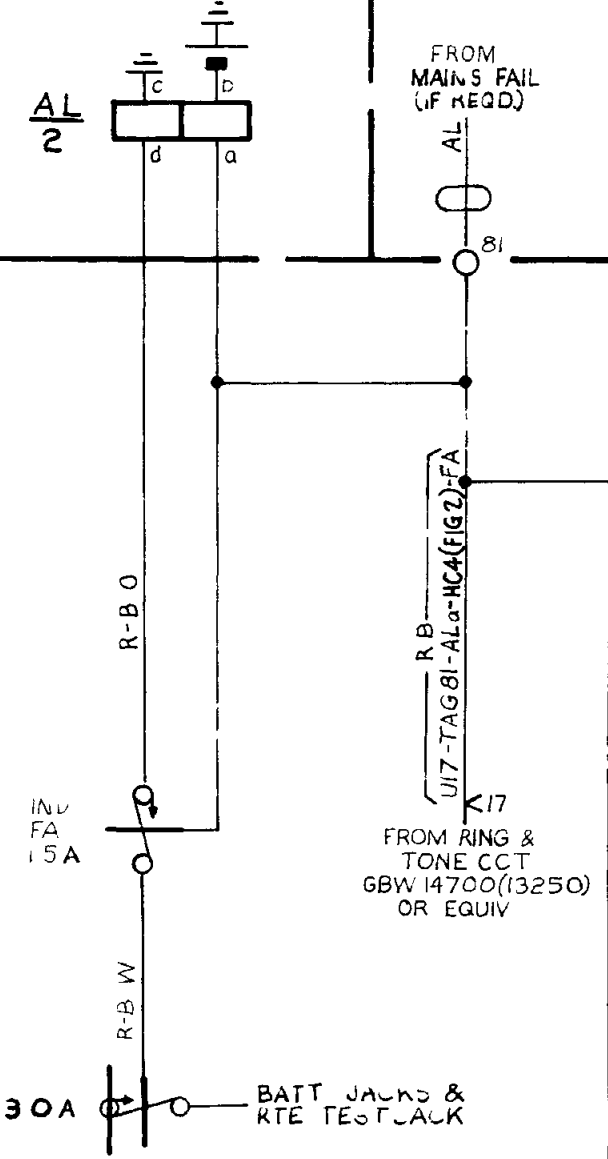

**FIG 1B**  
PER PABX

0 5 Centimetres 10 15 20 25 30 35 40 50 55

		SLOW RELEASE		SLOW OPERATE	
<b>RACK COMMON SERVICES</b>					
<b>35 &amp; 49 LINE PABX</b>					
REDRAWN TO A SIZE & METRICATED (157611)		4B	20978	N J H	
NZ NOTE A ADDED (30356)		4A	7472	G F E	
AMENDMENT PARTICULARS		ISS	DATE	APPD	
NZ PO		DRAWN	CHECKD	WIRING	CIRCUIT
40		JB	45	50	55
<b>GBW 13300</b>					SHT 12

**FIG 11**

INTERRUPTED RINGING DISTRIBUTION 1 PER PABX

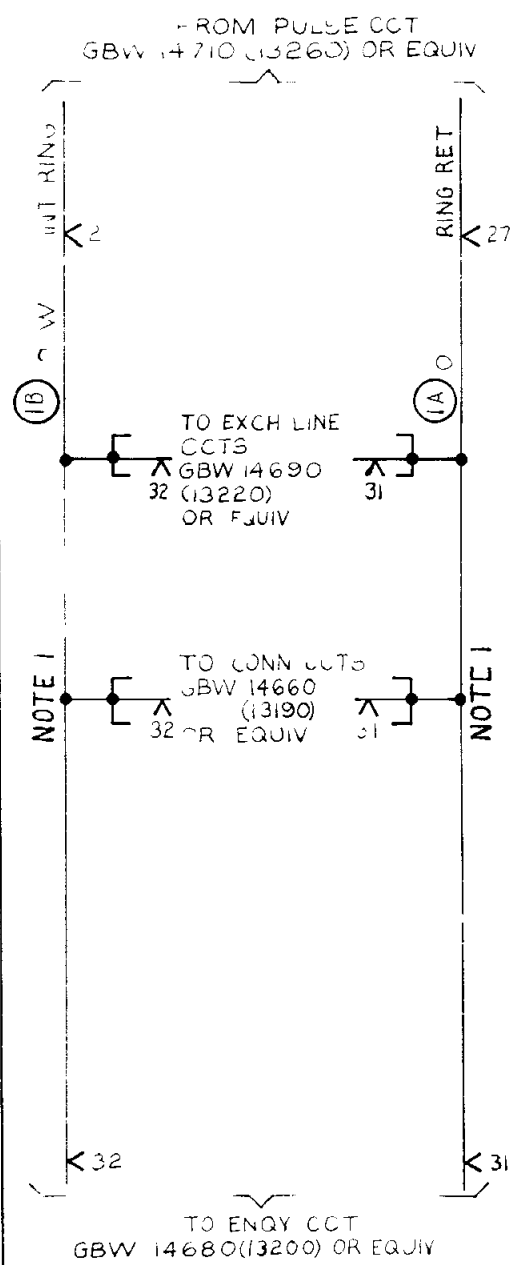

**FIG 12**

CONTINUOUS RINGING DISTRIBUTION 1 PER PABX

NZ NOTE A

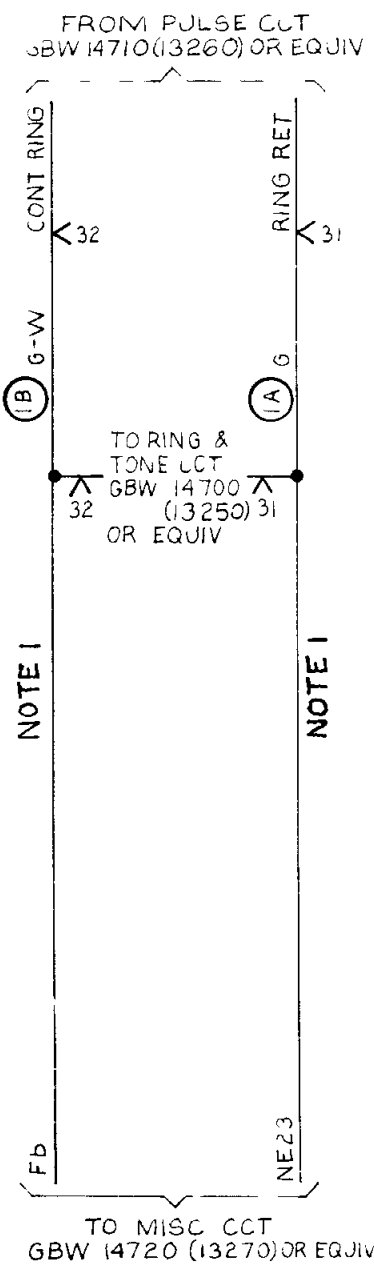

**FIG 13**

BUSY ETH DISTRIBUTION 1 PER PABX

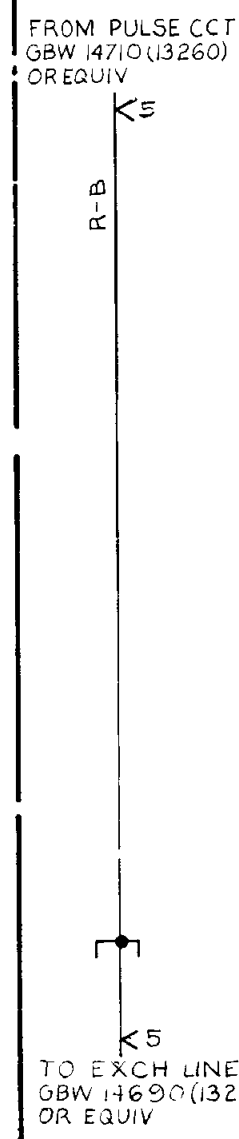

**FIG 14**

FLICKER ETH DISTRIBUTION 1 PER PABX

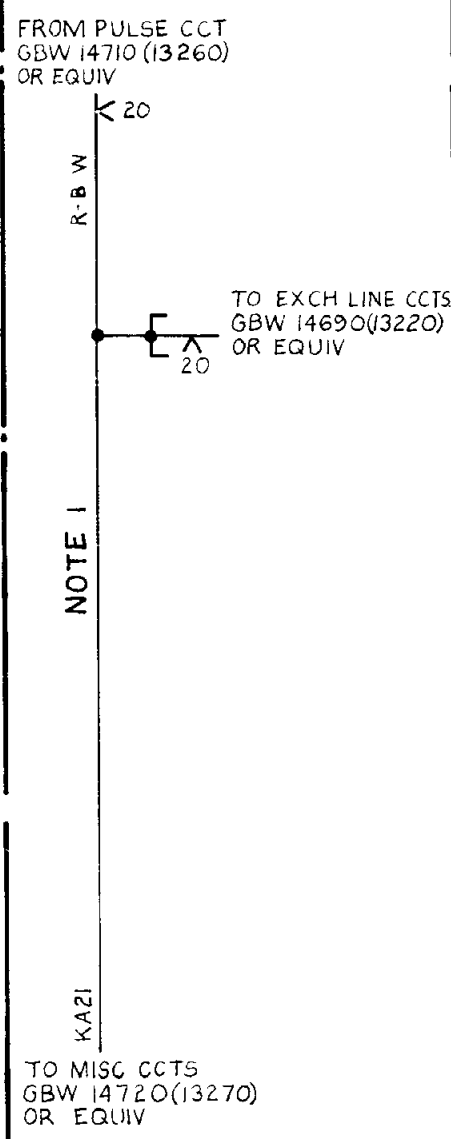

**FIG 15**

ROUTINE TEST JACK 1 PER PABX

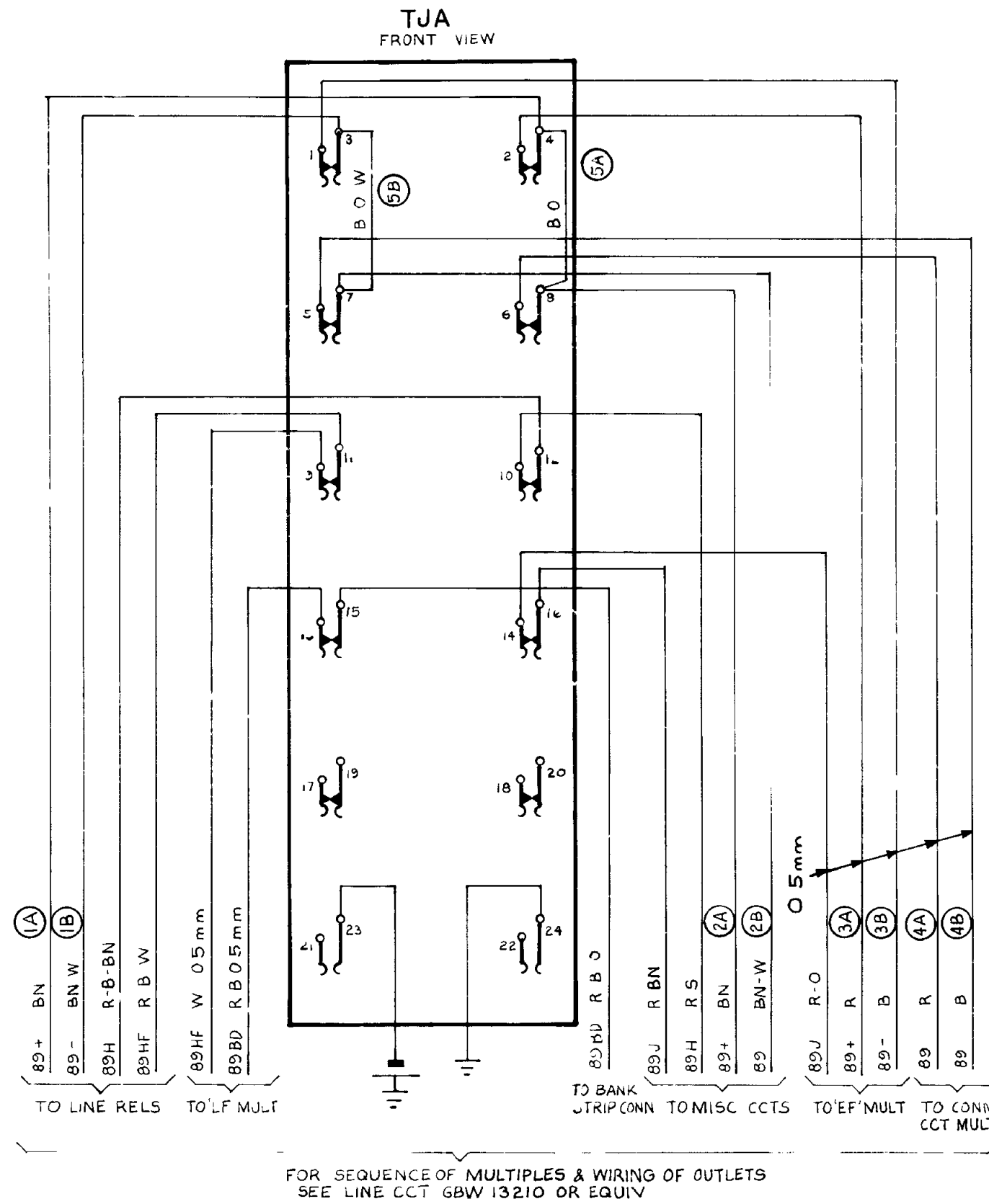

FOR BATT & ETH RUNS SEE FIG 3

SLOW RELEASE  SLOW OPERATE

REDRAWN TO A SIZE & METRICATED (157611) REFERENCE TO NZ NOTE A ADDED SHT 1 (30356)				4B	20 9 78	W JH	RACK COMMON SERVICES	
				4A	7 4 72	G F E	35 & 49 LINE PABX	
AMENDMENT PARTICULARS				ISS	DATE	APPD	SIZE A2	50 V W
NZPO 40				DRAWN JB	CHECKD 45	WIRING	CIRCUIT	GBW 13300
							50	55