

QUS1A, QUS1B, QUS1C, AND QUS1C1

“COMPANION\*” HANDS-FREE UNITS

CONNECTIONS (NON-NORTHERN ELECTRIC TELEPHONE SETS)

CONTENTS	PAGE
1. GENERAL . . . . .	1
2. CONNECTIONS . . . . .	1
POWER . . . . .	1
QUS1A . . . . .	2
QUS1B, QUS1C1 . . . . .	2
QUS1C . . . . .	3

2. CONNECTIONS

POWER

2.01 Each COMPANION unit is powered by a separately mounted NE-2012B transformer (or equivalent power supply) which is connected to the unit through the associated telephone set. A 115 V 50/60 Hz commercial power outlet is required for the transformer.

2.02 The maximum allowable lengths of 22, 24, and 26 AWG cable for connecting the NE-2012B transformer to the hands-free unit are:

- 22 AWG – 400 feet
- 24 AWG – 250 feet
- 26 AWG – 150 feet.

2.03 The power supply is connected to the telephone set through spare conductors in the mounting cord or by installing an additional 2-conductor cord.

2.04 A common power supply may be used for multiple installations but is not recommended. If a common power supply is used, the following conditions must be met to prevent degradation of performance and possible damage to the unit.

- (a) The power supply output *should not be grounded.*

1. GENERAL

1.01 This section contains information required for connection of the QUS1A, QUS1B, QUS1C, and QUS1C1 COMPANION hands-free units to non-Northern Electric telephone sets in general use in North America.

1.02 Information required for connection of these units to telephone sets manufactured by Northern Electric is contained in Section 512-6256-400.

1.03 In this section the term line switch (LS) refers to the contacts which are operated when the handset is lifted.

1.04 In this section the term network refers to the transmission unit in the telephone set.

\*Registered Trademark of Northern Electric

**SECTION 512-6256-401**

(b) The power supply should be 27 V ac  $\pm 10\%$  with 80 ohms series resistance or 36 V dc  $\pm 10\%$  with 170 ohms series resistance. The series resistance includes wiring and internal resistance of the power supply.

*Note:* A resistor should be added in series if the resistance of the loop plus the internal resistance of the power supply is less than the required series resistance.

**QUS1A**

2.05 Information required for connection of the QUS1A hands-free unit to any telephone set is given in the block schematic diagram shown in Fig. 1.

**QUS1B, QUS1C1**

2.06 The block schematic diagram for the QUS1B and QUS1C1 units is given in Fig. 2. Connection and telephone set conversion information required for the connection of these units to various non-Northern Electric telephone sets is given in the following tables:

**TABLE A – AUTOMATIC ELECTRIC TYPE 80**

**TABLE B – AUTOMATIC ELECTRIC TYPE 90M, 182A**

**TABLE C – AUTOMATIC ELECTRIC TYPE 186 WITH ROTARY DIAL**

**TABLE D – AUTOMATIC ELECTRIC TYPE 186 WITH TOUCH CALLING UNIT**

**TABLE E – AUTOMATIC ELECTRIC TYPE 860B**

**TABLE F – STROMBERG-CARLSON S-C AC2**

**TABLE G – STROMBERG-CARLSON S-C.500D, S-C 554B, S-C 2500D, S-C 2554B**

**TABLE H – STROMBERG-CARLSON 1704-6, 1704-6A, 1704-6B, 1704-12, 1704-12A, 1704-12B, 1704-6T, 1704-6AT, 1704-6BT, 1704-12T, 1704-12AT, 1704-12BT**

**TABLE I – ITT KELLOGG K-500, K-554, K-2500, K-2554**

**TABLE J – ITT KELLOGG 564 – (BA) 30/40 M 565 – (BA) 30/40 M**

**TABLE K – ITT KELLOGG 2564 – (BA) 30/40 M**

**TABLE L – ITT KELLOGG 2564 – (BA) 30/40 M 2565 – (BA) 30/40 M EQUIPPED WITH AN NE-35Q3B (OR EQUIVALENT) "DIGITONE\*" DIAL**

2.07 The unit should be connected with the NE-D16QC cord attached directly to the telephone set as shown in Fig. 3(a). If this is not possible, the connection may be made at an external connecting block as shown in Fig. 3(b).

2.08 Connection information for the optional features, i.e., common signal or bridged ringer cutoff, external station busy lamp or relay control, and auxiliary transfer contacts for optional control, is given in Fig. 4, 5, and 6.

2.09 Schematic diagrams of connections to typical telephone set are given in Fig. 7 through 12.

2.10 If a diode is required for an add-on feature in the associated telephone set:

(a) Make the connections as for the station busy lamp (see appropriate table).

\* Registered Trademark of Northern Electric

(b) Refer to the appropriate section on the associated telephone set for information on the add-on feature.

## QUS1C

2.11 The QUS1C unit is equipped with a plug on the right side which mates with the jack on the left side of the LOGIC 10\* telephone set. The block schematic diagram for the connection is shown in Fig. 2.

2.12 To prepare the LOGIC 10 telephone set for connection to the QUS1C unit, the filler plate in the left side must be removed and replaced with the jack which is stored inside the telephone set.

2.13 To connect the QUS1C unit to the LOGIC 10 telephone set for a desk-top installation:

- (a) Hold the set in the right hand with the dial forward.
- (b) Hold the unit in the left hand with the controls forward.
- (c) Tilt the upper edge of the unit towards the upper edge of the set and bring together so that the plug is firmly in the jack.

2.14 To connect the unit and the LOGIC 10 telephone set for a wall-mounted installation:

- (a) Mount a QVP7A mounting bracket securely on the wall. (The mounting bracket must be ordered separately.)
- (b) Place the set in position on the mounting bracket. Slide the set to the right, and secure it with the thumb screw.
- (c) Tilt the upper edge of the unit towards the upper edge of the set, and bring the unit

together with the set so that the plug is firmly in the jack and the unit is secured on the locking pin.

2.15 The power supply is connected through the LOGIC 10 telephone set in either of the following ways:

- (a) Connect the NE-2012B transformer (or equivalent power supply) with a 2-conductor cord to terminals 17 and 23 of the terminal block in the LOGIC 10 telephone set.
- (b) Connect the NE-2012B transformer (or equivalent power supply) to the LOGIC 10 telephone set through the connector cable. For an A25B connector cable, connect the transformer to the (G-R) and (S-W) leads of the cable. For any other connector cable, use the leads that terminate on pins 5 and 8 of the connector.

2.16 If the common signal cutoff feature is required:

- (a) Remove (S-Y) lead from the telephone set network terminal 2L, and connect to terminal 27 on the terminal block.
- (b) Remove (S-BK) lead from terminal 37 on the terminal block, and connect to terminal 2L on the network.

2.17 The auxiliary transfer contacts are not available with the LOGIC 10 telephone set.

2.18 The BL lead for external station busy lamp or relay control is terminated on terminals 10 through 12 of the LOGIC 10 telephone set.

\*Registered Trademark of Northern Electric

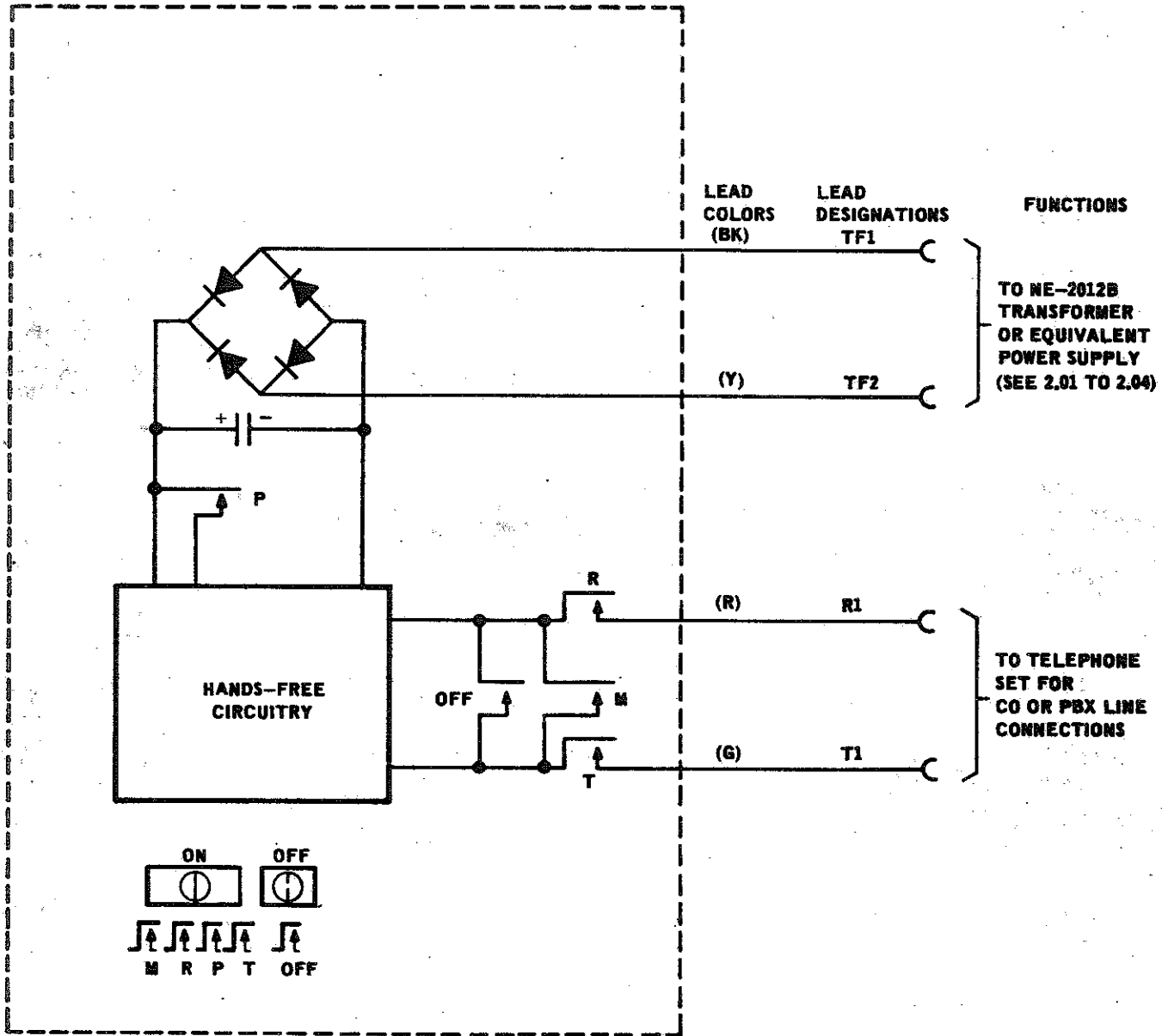

**NOTE: WHEN ON KEY IS MOMENTARILY DEPRESSED CONTACTS R, P, AND T LOCK MECHANICALLY AND CONTACT M OPERATES MOMENTARILY. WHEN OFF KEY IS MOMENTARILY DEPRESSED OFF CONTACTS OPERATE MOMENTARILY AND CONTACTS R, P, AND T RELEASE AS THE OFF KEY IS RELEASED.**

Fig. 1 — QUS1A Hands-Free Unit Block Schematic Diagram Showing Connections to a Telephone Set

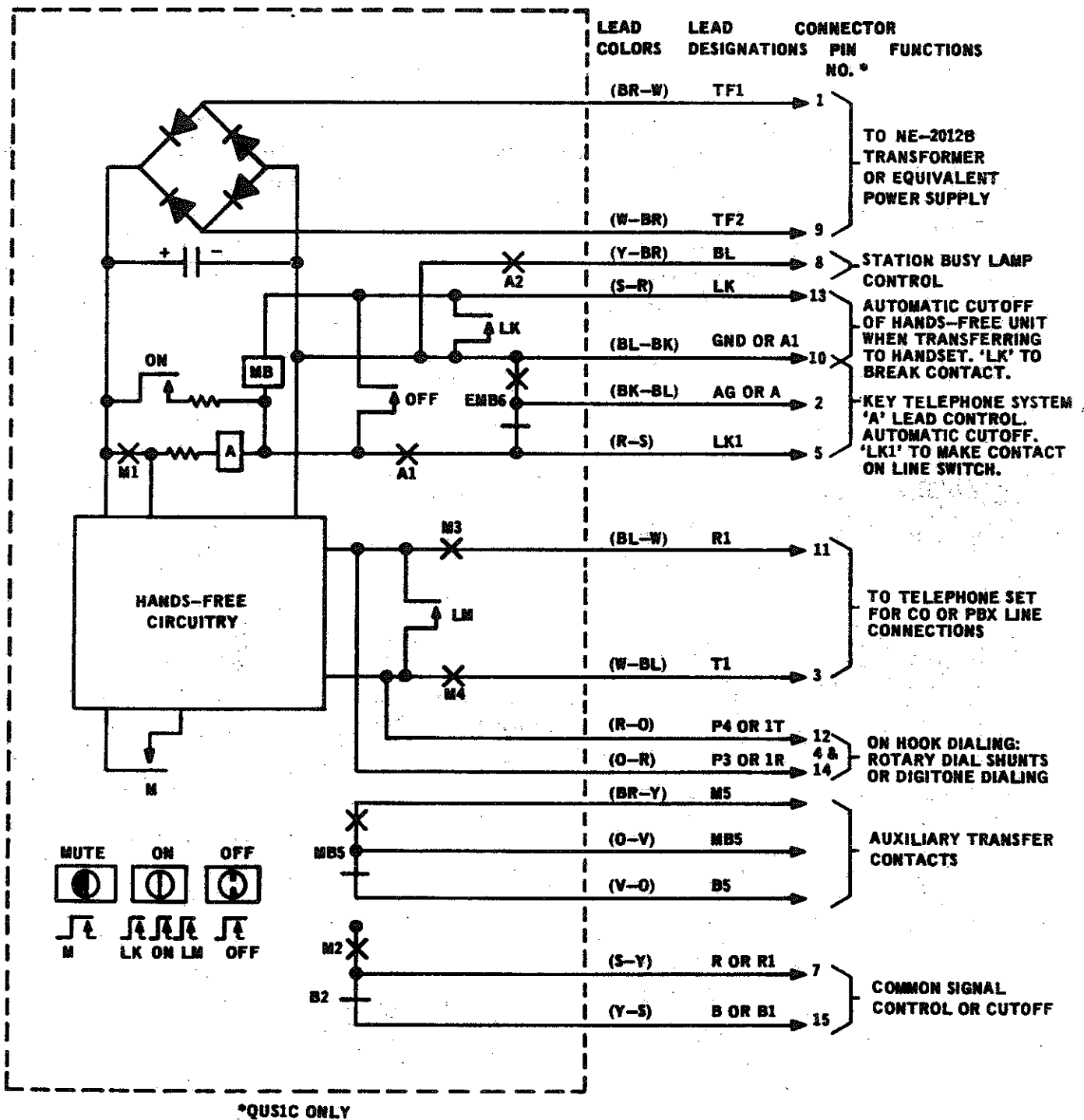
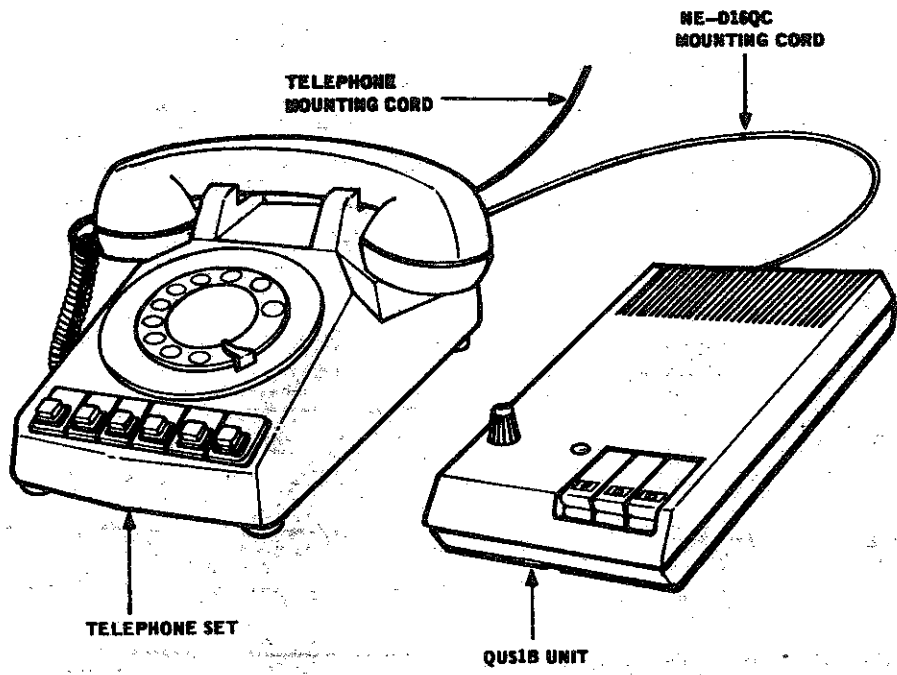
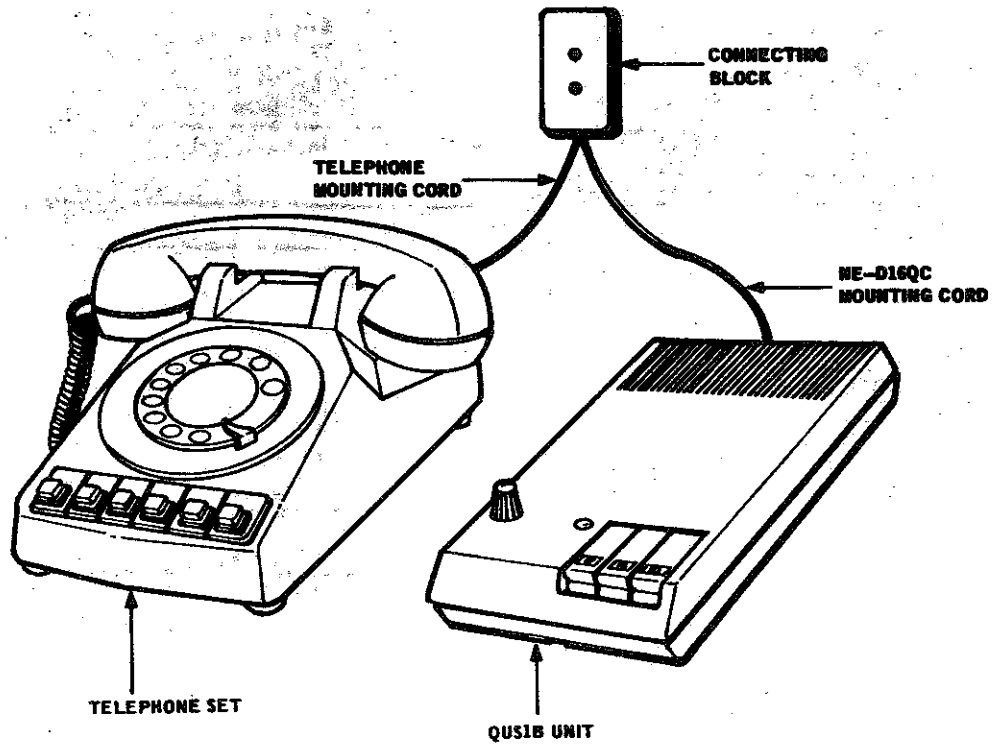

Fig. 2 - QUS1B and QUS1C Hands-Free Unit Block Schematic Diagram Showing Connections to a Telephone Set



(a) Connected Directly to Telephone Set



(b) Connected via Connecting Block to Telephone Set

Fig. 3 - QUS1B Hands-Free Unit, Telephone Set Connection

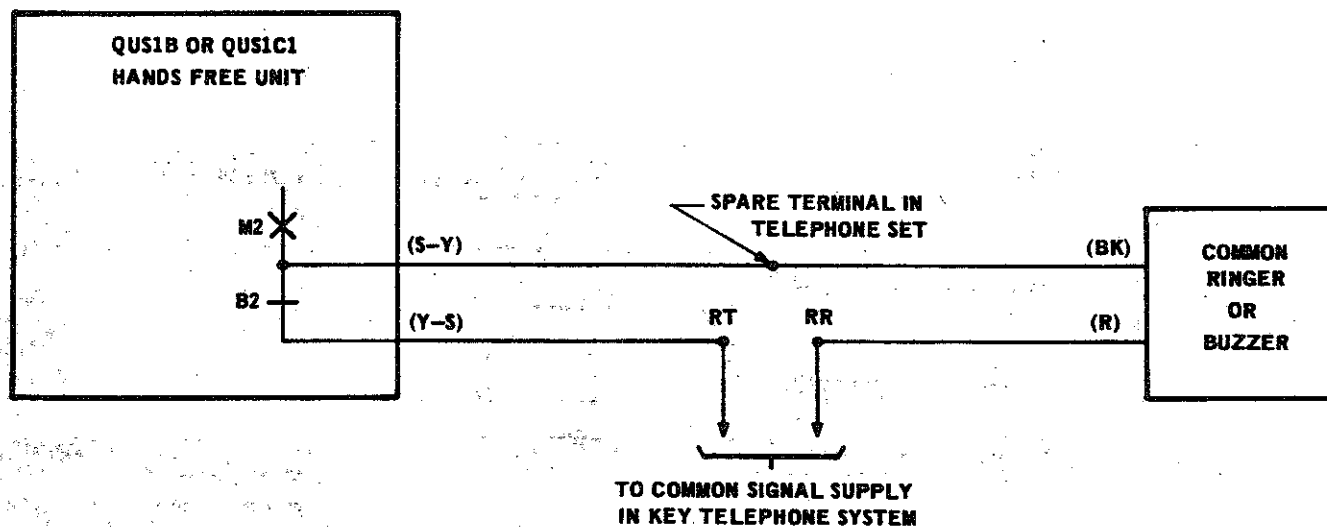

(a) Common Signal Cutoff

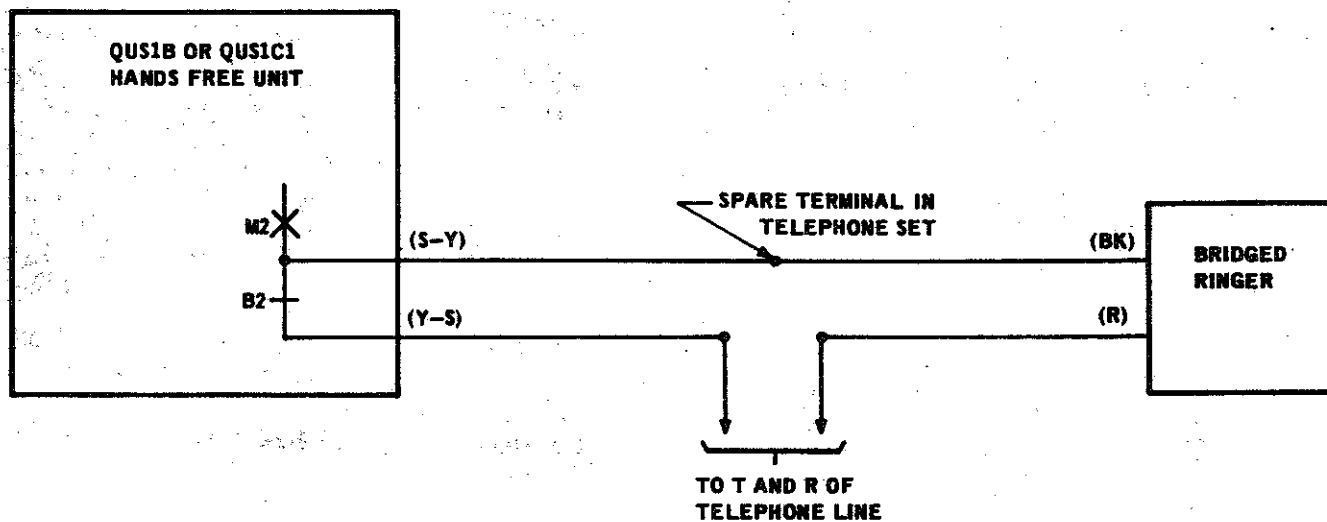

(b) Bridged Ringer Cutoff

Fig. 4 - Ringer Cutoff

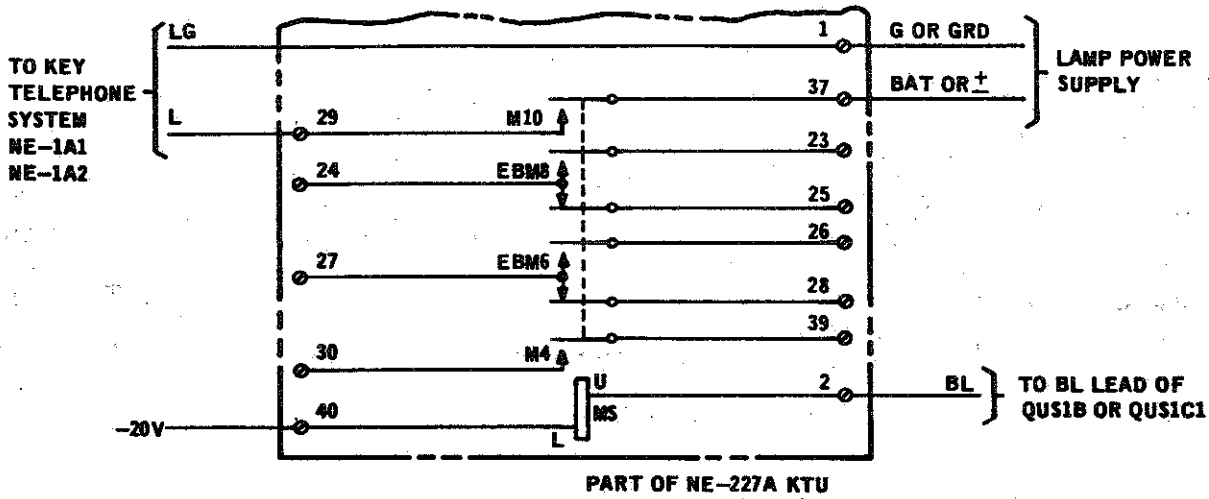

Fig. 5 - External Station Busy Lamp or Relay Control

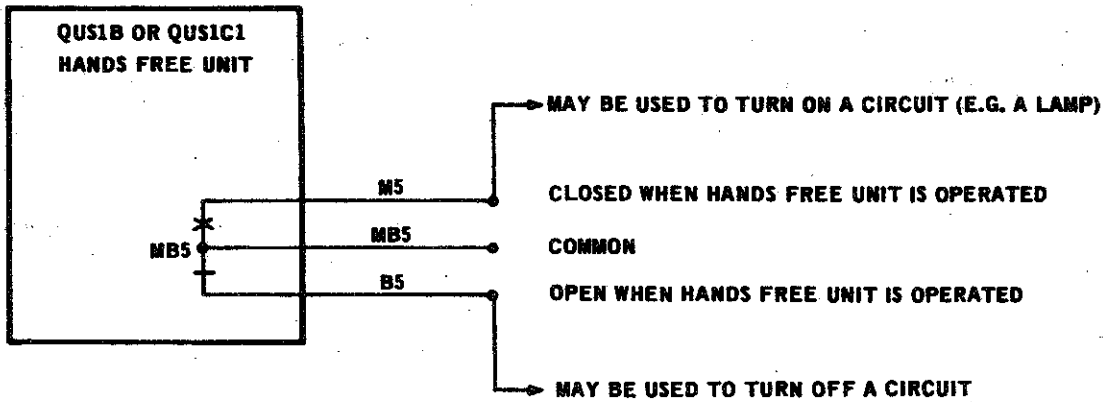

Fig. 6 - Auxiliary Transfer Contacts for Optional Control



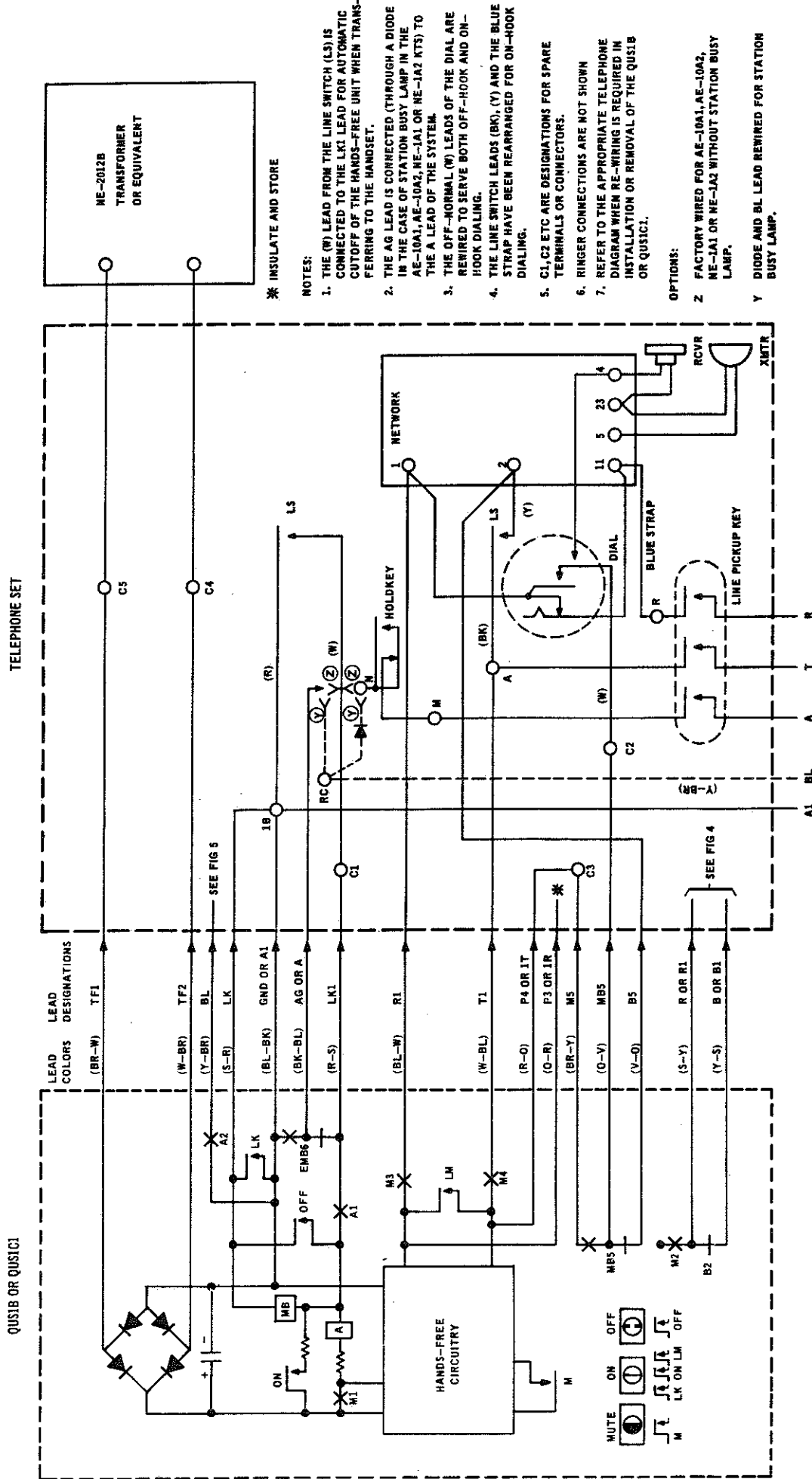
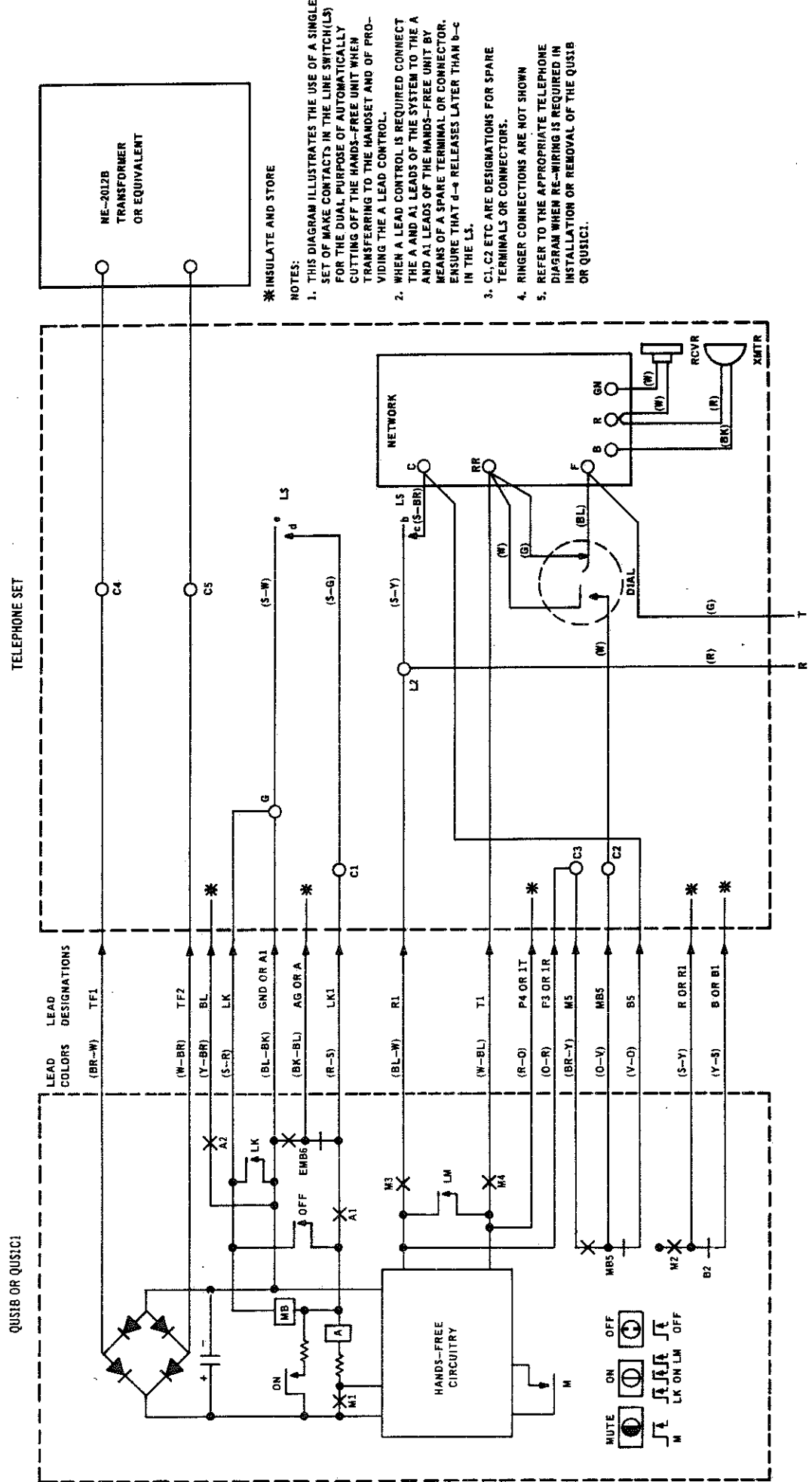

Fig. 7 - Connections to a Rotary Dial Key Telephone Set Automatic Electric Type 186



\* INSULATE AND STORE

NOTES:

1. THIS DIAGRAM ILLUSTRATES THE USE OF A SINGLE SET OF MAKE CONTACTS IN THE LINE SWITCH (LS) FOR THE DUAL PURPOSE OF AUTOMATICALLY CUTTING OFF THE HANDS-FREE UNIT WHEN TRANSFERRING TO THE HANDSET AND OF PROVIDING THE A LEAD CONTROL.
2. WHEN A LEAD CONTROL IS REQUIRED CONNECT THE A AND A1 LEADS OF THE SYSTEM TO THE A AND A1 LEADS OF THE HANDS-FREE UNIT BY MEANS OF A SPARE TERMINAL OR CONNECTOR. ENSURE THAT d → RELEASES LATER THAN b-c IN THE LS.
3. C1, C2 ETC ARE DESIGNATIONS FOR SPARE TERMINALS OR CONNECTORS.
4. RINGER CONNECTIONS ARE NOT SHOWN
5. REFER TO THE APPROPRIATE TELEPHONE DIAGRAM WHEN RE-WIRING IS REQUIRED IN INSTALLATION OR REMOVAL OF THE QUSIB OR QUSIC1.

Fig. 8 -- Connections to a Single Line Rotary Dial Telephone Set Stromberg-Carlson S-C5000

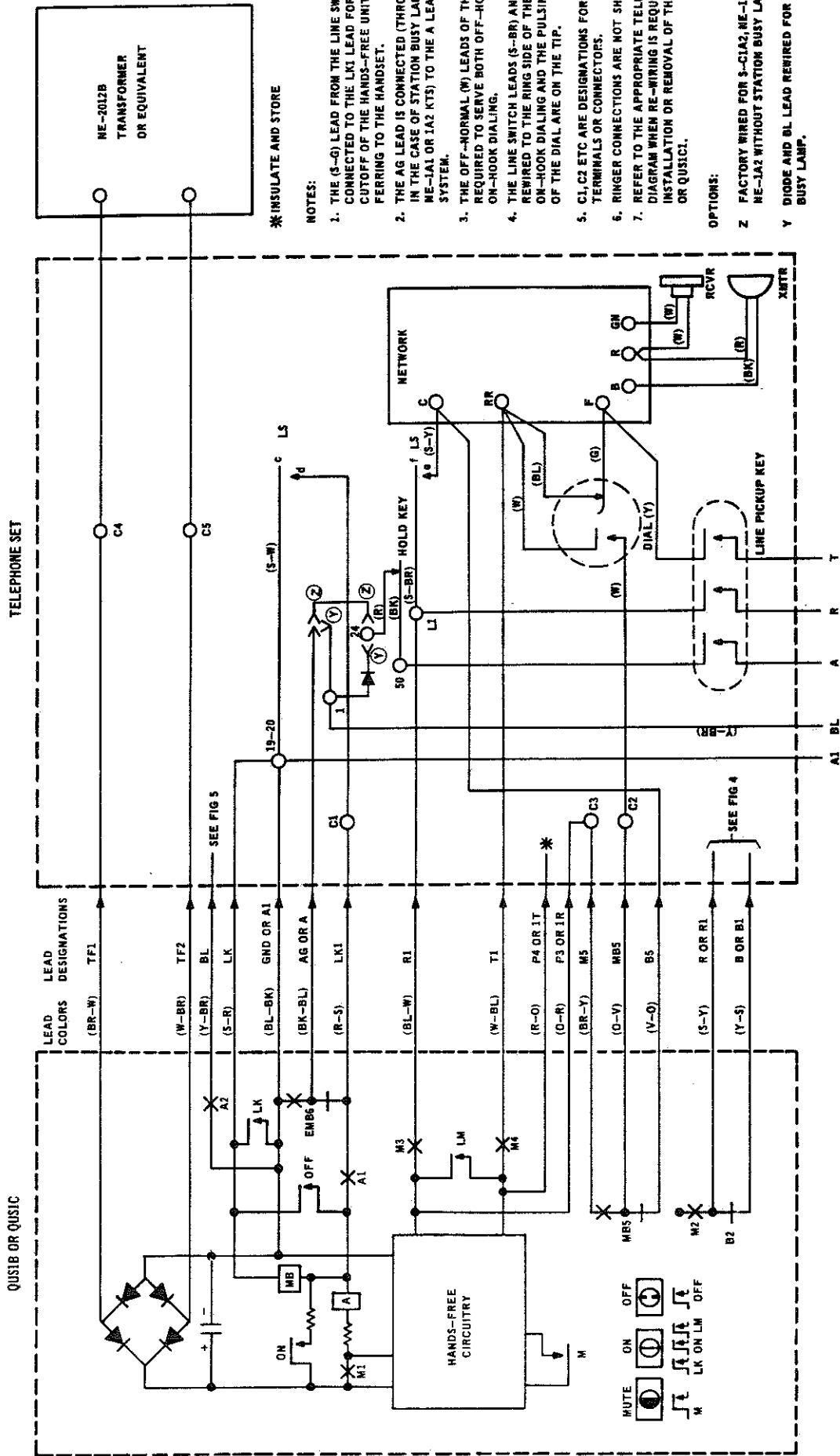

\* INSULATE AND STORE

NOTES:

1. THE (S-G) LEAD FROM THE LINE SWITCH (LS) IS CONNECTED TO THE LK1 LEAD FOR AUTOMATIC CUTOFF OF THE HANDS-FREE UNIT WHEN TRANSFERRING TO THE HANDSET.
2. THE AG LEAD IS CONNECTED (THROUGH A DIODE IN THE CASE OF STATION BUSY LAMP IN THE NE-1A1 OR 1A2 KTS) TO THE A LEAD OF THE SYSTEM.
3. THE OFF-NORMAL (W) LEADS OF THE DIAL ARE REQUIRED TO SERVE BOTH OFF-HOOK AND ON-HOOK DIALING.
4. THE LINE SWITCH LEADS (S-BR) AND (S-Y) ARE REQUIRED TO THE RING SIDE OF THE LINE FOR ON-HOOK DIALING AND THE PULSING CONTACTS OF THE DIAL ARE ON THE TIP.
5. C1, C2 ETC ARE DESIGNATIONS FOR SPARE TERMINALS OR CONNECTORS.
6. RINGER CONNECTIONS ARE NOT SHOWN
7. REFER TO THE APPROPRIATE TELEPHONE DIAGRAM WHEN RE-WIRING IS REQUIRED IN INSTALLATION OR REMOVAL OF THE QUSIB OR QUSIC1.

OPTIONS:

- Z FACTORY WIRED FOR S-C1A2, NE-1A1 OR NE-1A2 WITHOUT STATION BUSY LAMP.
- Y DIODE AND BL LEAD REQUIRED FOR STATION BUSY LAMP.

Fig. 9 - Connections to a Rotary Dial Key Telephone Set  
Stromberg - Carlson Type 1704

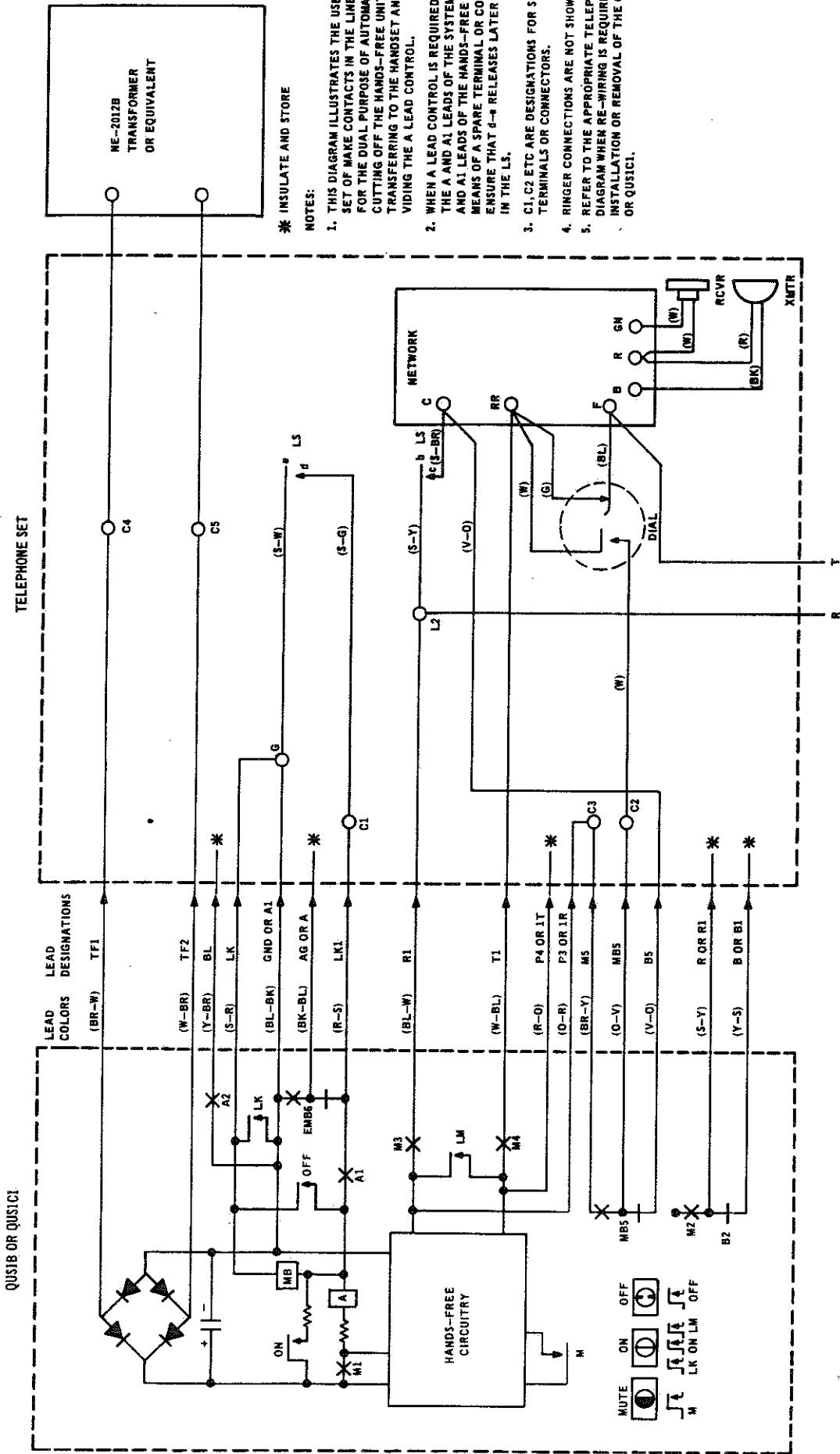

\* INSULATE AND STORE

NOTES:

1. THIS DIAGRAM ILLUSTRATES THE USE OF A SINGLE SET OF MAKE CONTACTS IN THE LINE SWITCH (LS) FOR THE DUAL PURPOSE OF AUTOMATICALLY CUTTING OFF THE HANDS-FREE UNIT WHEN TRANSFERRING TO THE HANDSET AND OF PROVIDING THE A LEAD CONTROL.
2. WHEN A LEAD CONTROL IS REQUIRED CONNECT THE A AND A1 LEADS OF THE SYSTEM TO THE A AND A1 LEADS OF THE HANDS-FREE UNIT BY MEANS OF A SPARE TERMINAL OR CONNECTOR. ENSURE THAT 6-4 RELEASES LATER THAN 6-c IN THE LS.
3. C1, C2 ETC ARE DESIGNATIONS FOR SPARE TERMINALS OR CONNECTORS.
4. RINGER CONNECTIONS ARE NOT SHOWN
5. REFER TO THE APPROPRIATE TELEPHONE DIAGRAM WHEN RE-WIRING IS REQUIRED IN INSTALLATION OR REMOVAL OF THE QUSIB OR QUSICI.

Fig. 10 - Connections to a Single Line Rotary Dial Telephone Set ITT Kellogg K-500 Type

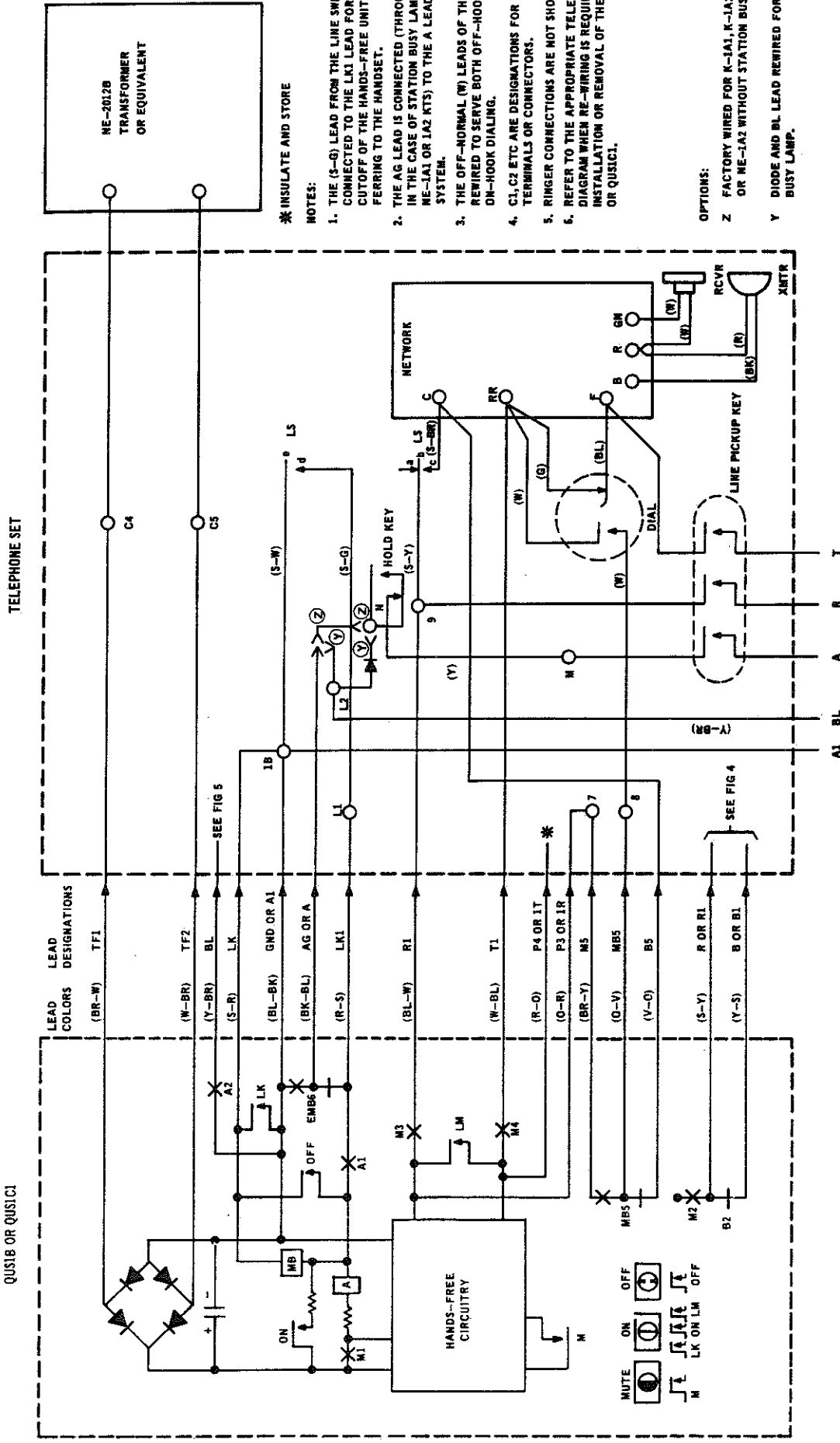

\* INSULATE AND STORE

NOTES:

1. THE (S-G) LEAD FROM THE LINE SWITCH (LS) IS CONNECTED TO THE LK1 LEAD FOR AUTOMATIC CUTOFF OF THE HANDS-FREE UNIT WHEN TRANSFERRING TO THE HANDSET.
2. THE AG LEAD IS CONNECTED (THROUGH A DIODE IN THE CASE OF STATION BUSY LAMP IN THE NE-1A1 OR 1A2 KTS) TO THE A LEAD OF THE SYSTEM.
3. THE OFF-NORMAL (W) LEADS OF THE DIAL ARE REQUIRED TO SERVE BOTH OFF-HOOK AND ON-HOOK DIALING.
4. C1, C2 ETC ARE DESIGNATIONS FOR SPARE TERMINALS OR CONNECTORS.
5. RINGER CONNECTIONS ARE NOT SHOWN
6. REFER TO THE APPROPRIATE TELEPHONE DIAGRAM WHEN RE-WIRING IS REQUIRED IN INSTALLATION OR REMOVAL OF THE QUS1B OR QUS1C1.

OPTIONS:

- Z FACTORY WIRED FOR K-1A1, K-1A2, NE-1A1 OR NE-1A2 WITHOUT STATION BUSY LAMP.
- Y DIODE AND BL LEAD REQUIRED FOR STATION BUSY LAMP.

Fig. 11 - Connections to a Rotary Dial Key Telephone Set  
ITT Kellogg Type 564 or 565

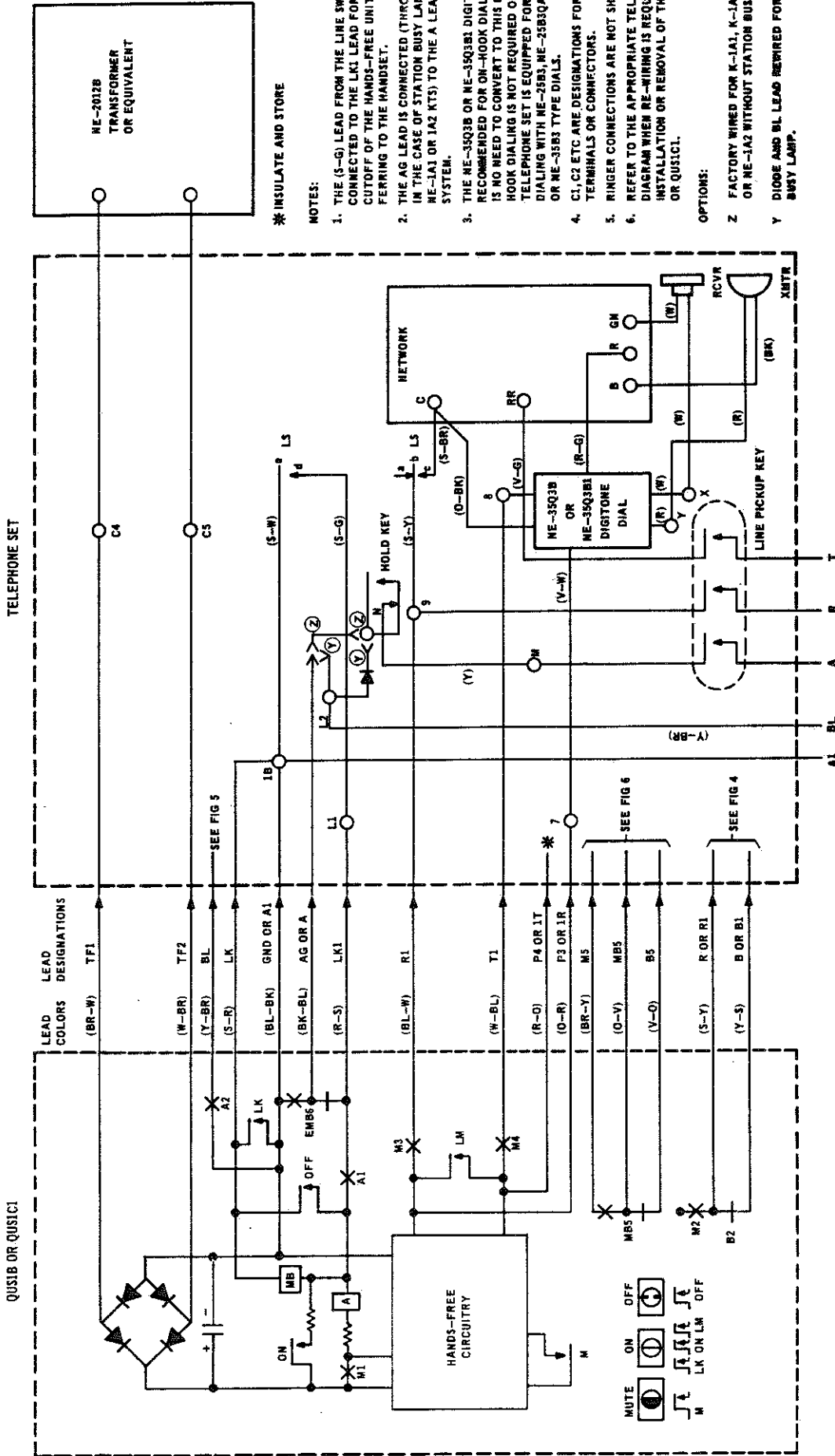

Fig. 12 - Connections to a Pushbutton Dial Key Telephone Set ITT Kellogg Type 2564

**TABLE A**  
**AUTOMATIC ELECTRIC TYPE 80**

TELEPHONE SETS				TYPE 80 WITH ROTARY DIAL				TYPE 80: WITH TOUCH CALLING UNIT				
TELEPHONE SYSTEM				INDIVIDUAL OR BRIDGED CO OR PBX LINE								
ITEM	LEAD COLORS	LEAD DESIGNATIONS	FROM		TO		FROM		TO			
			TERMINALS		TERMINALS		TERMINALS		TERMINALS			
			SET	NETWORK	SET	NETWORK	SET	NETWORK	SET	NETWORK		
TELEPHONE SET CONVERSIONS	Line switch leads	(BK) (Y)		10 11	C1† C2			D	10	C1 C2		
	Jumper or NE-M1W cord		Y			Y	10 11					
	Dial leads	(W)		2	C3							
	Touch calling unit lead	(R)					D				10	
QUSIB AND QUSICI UNITS NE-D16QC CORD	CO or PBX line	(BL-W) (W-BL)	R1 T1				1 8				10 8	
	Power supply leads	(BR-W) (W-BR)	TF1 TF2	Connect to output leads from NE-2012B transformer (or equivalent) using spare terminals or QCM12A connectors.								
	Automatic cutoff of unit when transferring to handset, and key telephone system A lead control	(S-R) (R-S) (BL-BK) (BK-BL)	LK LK1 GND or A1 AG or A			C2 C1 C2 *					C2 C1 C2 *	
	On-hook dialing	(O-R) (R-O) (V-O) (O-V) (BR-Y)	P3 or 1R P4 or 1T B5 MB5 M5			* C4  C3 C4	2				* *	Auxiliary transfer contacts for optional control. See Fig. 6
	External station busy lamp or relay control	(Y-BR)	BL	See Fig. 5				See Fig. 5				
	Common signal cutoff or bridged ringer cutoff	(S-Y) (Y-S)	R or R1 B or B1	See Fig. 4				See Fig. 4				

\* Insulate and store.  
† Leads designated C1, C2, etc., in table must be bridged to leads with identical designations using QCM12A connectors or spare terminals.  
‡ On-hook dialing not available.

**TABLE B**  
**AUTOMATIC ELECTRIC TYPE 90M, 182A**

TELEPHONE SETS				TYPE 90M† WITH ROTARY DIAL				STARLITE‡§ 182A (WITH ROTARY DIAL)			
TELEPHONE SYSTEM				INDIVIDUAL OR BRIDGED CO OR PBX LINE							
ITEM	LEAD COLORS	LEAD DESIGNATIONS	FROM		TO		FROM		TO		
			TERMINALS		TERMINALS		TERMINALS		TERMINALS		
			SET	NETWORK	SET	NETWORK	SET	NETWORK	SET	NETWORK	
TELEPHONE SET CONVERSIONS	Line switch leads	(BK) (Y)		10 11	C1† C2				10 11	C1 C2	
	Jumper or NE-M1W cord		Y			Y	10 11				Y
QUS1B AND QUS1C1 UNITS NE-D16QC CORD	CO or PBX line	(BL-W) (W-BL)	R1 T1			10 8				10 8	
	Power supply leads	(BR-W) (W-BR)	TF1 TF2	Connect to output leads from NE-2012B transformer (or equivalent) using spare terminals or QCM12A connectors.							
	Automatic cutoff of unit when transferring to handset, and key telephone system A lead control	(S-R) (R-S) (BL-BK) (BK-BL)	LK LK1 GND or A1 AG or A			C2 C1 C2 *				C2 C1 C2 *	
	On-hook dialing	(O-R) (R-O)	P3 or 1R P4 or 1T			*				*	
	Auxiliary transfer contacts for optional control	(V-O) (O-V) (BR-Y)	B5 MB5 M5	See Fig. 6				See Fig. 6			
	External station busy lamp or relay control	(Y-BR)	BL	See Fig. 5				See Fig. 5			
	Common signal cutoff or bridged ringer cutoff	(S-Y) (Y-S)	R or R1 B or B1	See Fig. 4				See Fig. 4			



\* Insulate and store.  
 † Leads designated C1, C2, etc., in table must be bridged to leads with identical designations using QCM12A connectors or spare terminals.  
 ‡ On-hook dialing not available.  
 § Change the mounting cord to one with at least 11 conductors, or install an additional 6-conductor cord for connection to the NE-D16QC cord at the connecting block.



**TABLE C  
AUTOMATIC ELECTRIC TYPE 186**

TELEPHONE SETS				TYPE 186 WITH ROTARY DIAL									
				ARRANGED FOR HOLD KEY AND 5 PICKUP KEYS					ARRANGED FOR 6 PICKUP KEYS				
KEY TELEPHONE SYSTEMS				AE-10A1, AE-10A2, NE-1A1, NE-1A2									
STATION BUSY LAMP CIRCUIT				NO		YES		NO		YES			
ITEM	LEAD COLORS	LEAD DESIGNATIONS	TERMINALS			TERMINALS			TERMINALS			TERMINALS	
			FROM	KEY	NETWORK	KEY	NETWORK	FROM	KEY	NETWORK	KEY	NETWORK	
TELEPHONE SET CONVERSIONS	Line switch leads	(BK) (Y) (W)		R 11 N	A C1†	2	A C1	2	N 11 M	A C1	2	A C1	2
	Jumper or NE-M1W cord	(BL)		A 2	R	(11)	R	(11)	A 2	N	(11)	N	(11)
	Dial leads	(W)		2	C2		C2		2	C2		C2	
	Diode assembly PO522718 or diode NSQ8034L1 (1N4384) for station busy lamp							ORC N					ORC M
QUS1B AND QUS1C1 UNITS NE-D16QC CORD	CO or PBX line	(BL-W) (W-BL)	R1 T1		A	1	A	1		A	1	A	1
	Power supply leads	(BR-W) (W-BR)	TF1 TF2	Connect to output leads from NE-2012B transformer (or equivalent) using spare terminals or QCM12A connectors.									
	Automatic cutoff of unit when transferring to handset, and key telephone system A lead control	(S-R) (R-S) (BL-BK) (BK-BL)	LK LK1 GND or A1 AG or A		1B C1 1B N		1B C1 1B RC			1B C1 1B M		1B C1 1B RC	
	On-hook dialing	(O-R) (R-O) (V-O) (O-V) (BR-Y)	P3 or 1R P4 or 1T B5 MB5 M5		* C3 C2 C3	2	* C3 C2 C3	2		* C3 C2 C3	2	* C3 C2 C3	2
	External station busy lamp or relay control	(Y-BR)	BL	See Fig. 5					See Fig. 5				
	Common signal cutoff or bridged ringer cutoff	(S-Y) (Y-S)	R or R1 B or B1	See Fig. 4					See Fig. 4				
* Insulate and store. † Leads designated C1, C2, etc., in table must be bridged to leads with identical designations using QCM12A connectors or spare terminals.													

**TABLE D**  
**AUTOMATIC ELECTRIC TYPE 186 WITH TOUCH CALLING UNIT**

TELEPHONE SETS				TYPE 186 WITH TOUCH CALLING UNIT									
				ARRANGED FOR HOLD KEY AND 5 PICKUP KEYS					ARRANGED FOR 6 PICKUP KEYS				
KEY TELEPHONE SYSTEMS				AE-10A1, AE-10A2, NE-1A1, NE-1A2									
STATION BUSY LAMP CIRCUIT				NO		YES		NO		YES			
ITEM	LEAD COLORS	LEAD DESIGNATIONS	TERMINALS			TERMINALS			TERMINALS			TERMINALS	
			FROM	KEY	NETWORK	KEY	NETWORK	FROM	KEY	NETWORK	KEY	NETWORK	
TELEPHONE SET CONVERSIONS	Line switch leads	(W)		N	C1†		C1		M	C1		C1	
	Diode assembly PO522718 or diode NSQ8034L1 (1N4384) for station busy lamp												
QUS1B AND QUS1C1 UNITS NE-D16QC CORD	CO or PBX line	(BL-W) (W-BL)	R1 T1		R A		R A			N A		N A	
	Power supply leads	(BR-W) (W-BR)	TF1 TF2	Connect to output leads from NE-2012B transformer (or equivalent) using spare terminals or QCM12A connectors.									
	Automatic cutoff of unit when transferring to handset, and key telephone system A lead control	(S-R) (R-S) (BL-BK) (BK-BL)	LK LK1 GND or A1 AG or A		1B C1 1B N		1B C1 1B RC			1B C1 1B M		1B C1 1B RC	
	On-hook dialing	(O-R) (R-O)	P3 or 1R P4 or 1T		*		*			*		*	
	Auxiliary transfer contacts for optional control	(V-O) (O-V) (BR-Y)	B5 MB5 M5	See Fig. 6					See Fig. 6				
	External station busy lamp or relay control	(Y-BR)	BL	See Fig. 5					See Fig. 5				
	Common signal cutoff or bridged ringer cutoff	(S-Y) (Y-S)	R or R1 B or B1	See Fig. 4					See Fig. 4				

\* Insulate and store.  
† Leads designated C1, C2, etc., in table must be bridged to leads with identical designations using QCM12A connectors or spare terminals.

**TABLE E**  
**AUTOMATIC ELECTRIC TYPE 860B**

TELEPHONE SETS				TYPE 860B									
				WITH ROTARY DIAL					WITH TOUCH CALLING UNIT†				
KEY TELEPHONE SYSTEMS				AE-10A1, AE-10A2, NE-1A1, NE-1A2									
STATION BUSY LAMP CIRCUIT				NO		YES		NO		YES			
ITEM	LEAD COLORS	LEAD DESIGNATIONS	TERMINALS			TERMINALS			TERMINALS			TERMINALS	
			FROM	KEY	NETWORK	KEY	NETWORK	FROM	KEY	NETWORK	KEY	NETWORK	
TELEPHONE SET CONVERSIONS	Line switch leads	(BK) (R) (O) (Y)		J E 11 8	J C1† C1	8	H C1 C1	8	J			H	
	Jumper or NE-M1W cord				E	(11)	E	(11)					
	Dial leads	(W)		2	C2		C2						
	Diode assembly POS22718 or diode NSQ8034L1 (1N4384) for station busy lamp												
QUSIB AND QUSIC1 UNITS NE-D16QC CORD	CO or PBX line	(BL-W) (W-BL)	R1 T1			1 8		1 8		E	8	E	8
	Power supply leads	(BR-W) (W-BR)	TF1 TF2	Connect to output leads from NE-2012B transformer (or equivalent) using spare terminals or QCM12A connectors.									
	Automatic cutoff of unit when transferring to handset, and key telephone system A lead control	(S-R) (R-S) (BL-BK) (BK-BL)	LK LK1 GND or A1 AG or A		*	6	*	6		*	6	*	6
	On-hook dialing	(O-R) (R-O) (V-O) (O-V) (BR-Y)	P3 or 1R P4 or 1T B5 MB5 M5		*	2	*	2		*		*	
					C3		C3			*		*	
					C2		C2		Auxiliary transfer contacts for optional control See Fig. 6				
External station busy lamp or relay control	(Y-BR)	BL	See Fig. 5					See Fig. 5					
Common signal cutoff or bridged ringer cutoff	(S-Y) (Y-S)	R or R1 B or B1	See Fig. 4					See Fig. 4					

\* Insulate and store.  
† Leads designated C1, C2, etc., in table must be bridged to leads with identical designations using QCM12A connectors or spare terminals.  
‡ On-hook dialing not available.

**TABLE F**  
**STROMBERG – CARLSON S-C AC2**

TELEPHONE SETS				S-C AC2† WITH S-C 220A HANDSET OR S-C 2220B HANDSET			
TELEPHONE SYSTEM				INDIVIDUAL OR BRIDGED CO OR PBX LINE			
	ITEM	LEAD COLORS	LEAD DESIGNATIONS	FROM		TO	
				TERMINALS		TERMINALS	
				SET	BOARD	SET	BOARD
TELEPHONE SET CONVERSIONS	Line switch leads	(W) (GN)			L1	C1†	F
	Handset cord jack lead	(G)			F		L1
QUS1B AND QUS1C1 UNITS NE-D16QC CORD	CO or PBX line	(BL-W) (W-BL)	R1 T1				L2 L1
	Power supply leads	(BR-W) (W-BR)	TF1 TF2	Connect to output leads from NE-2012B transformer (or equivalent) using spare terminals or QCM12A connectors.			
	Automatic cutoff of unit when transferring to handset, and key telephone system A lead control	(S-R) (R-S) (BL-BK) (BK-BL)	LK LK1 GND or A1 AG or A			C1 *	F F
	On-hook dialing	(O-R) (R-O)	P3 or 1R P4 or 1T			* *	
	Auxiliary transfer contacts for optional control	(V-O) (O-V) (BR-Y)	B5 MB5 M5	See Fig. 6			
	External station busy lamp or relay control	(Y-BR)	BL	See Fig. 5			
	Common signal cutoff or bridged ringer cutoff	(S-Y) (Y-S)	R or R1 B or B1	See Fig. 4			
<p>* Insulate and store.  † Leads designated C1, C2, etc., in table must be bridged to leads with identical designations using QCM12A connectors or spare terminals.  ‡ On-hook dialing not available.</p>							

TABLE G  
STROMBERG-CARLSON S.C. 5000,  
S.C. 554B, S.C. 2500D, S.C. 2554B

TELEPHONE SETS		S.C. 5000, S.C. 554B†		S.C. 2500D††		S.C. 2554B‡	
TELEPHONE SYSTEM		INDIVIDUAL OR BRIDGED CO OR PBX LINE				NE-1A1, NE-1A2 OR EQUIVALENT KTS	
ITEM	LEAD COLORS	LEAD DESIGNATIONS	FROM		TO		TERMINALS
			SET	NETWORK	SET	NETWORK	
Line switch leads	(S-W)** (S-G)		F LI	LI	C1	L1	
Telephone line leads	(R) (G)	R T	LI	L2 F	I	L2	
Dial leads	(W) (W)		GN R	RR	C2		
A Control leads		A A1		L1§ G§		L1§	L1§ G§
CO or PBX line	(BL-W) (W-BL)	R1 T1		L2 RR	I	L2	
Power supply leads	(BR-W) (W-BR)	TF1 TF2					
Automatic cutoff of unit when transferring to handset, and key telephone system A lead control	(S-R) (R-S) (BL-BK) (BK-BL)	LK LKI GND or A1 AG or A			C1 * * or C2§	L1 L1	
On-hook dialing	(O-R) (R-O) (V-O) (O-V) (BR-Y)	P3 or IR P4 or IT B5 MBS M5			C3 * *		
External station busy lamp or relay control	(Y-BR)	BL					
Common signal cutoff or bridged ringer cutoff	(S-Y) (Y-S)	R or R1 B or B1					

Connect to output leads from NE-2012B transformer (or equivalent) using spare terminals or OCW1 A, some terminals.

\* Insulate and store.  
† Leads designated C1, C2, etc., in table must be bridged to leads with identical designations using OCM 12A connectors or spare terminals.  
‡ On-hook dialing not available.  
§ Used only when A lead control is required.  
\*\* On the S.C. 2554B telephone set these colors are (W) and (G).  
†† On-hook dialing not available unless an NE-35Q3B or equivalent DIGITONE dial is used.

**TABLE H**  
**STROMBERG - CARLSON**  
 1704-6, 1704-6A, 1704-6B, 1704-12, 1704-12A, 1704-12B  
 1704-6T, 1704-6AT, 1704-6BT, 1704-12T, 1704-12AT, 1704-12BT





TELEPHONE SETS				1704-6, 1704-6A, 1704-6B 1704-12, 1704-12A, 1704-12B				1704-6T, 1704-6AT, 1704-6BT, 1704-12T, 1704-12AT, 1704-12BT					
KEY TELEPHONE SYSTEMS				S-C 1A2, NE-1A1, NE-1A2 OR EQUIVALENT									
STATION BUSY LAMP CIRCUIT				NO		YES		NO		YES			
ITEM	LEAD COLORS	LEAD DESIGNATIONS	TERMINALS			TERMINALS			TERMINALS			TERMINALS	
			FROM	KEY	NETWORK	KEY	NETWORK	FROM	KEY	NETWORK	KEY	NETWORK	
TELEPHONE SET CONVERSIONS	Line switch leads	(S-Y) (S-W) (S-G)		F 19-20 24	20 C1†	C		C		19-20 24	19-20 C1		19-20 C1
	Key leads	(Y) (BL)		L1 C		F L1		F L1					
	Dial leads	(W) (W)		GN R	C2	RR		RR					
	Diode assembly PO522718 or diode NSQ8034L1 (1N4384) for station busy lamp												
QUS1B AND QUS1C1 UNITS NE-D16QC CORD	CO or PBX line	(BL-W) (W-BL)	R1 T1			L1 RR		L1 RR			C L1		C L1
	Power supply leads	(BR-W) (W-BR)	TF1 TF2	Connect to output leads from NE-2012B transformer (or equivalent) using spare terminals or QCM12A connectors.									
	Automatic cutoff of unit when transferring to handset, and key telephone system A lead control	(S-R) (R-S) (BL-BK) (BK-BL)	LK LK1 GND or A1 AG or A		20 C1 20 24		20 C1 20 1			19-20 C1 19-20 24		19-20 C1 19-20 1	
	On-hook dialing	(O-R) (R-O) (V-O) (O-V) (BR-Y)	P3 or 1R P4 or 1T B5 MB5 M5		C3 * C2 C3		C3 * C2 C3		C C		* *		* *
	External station busy lamp or relay control	(Y-BR)	BL	See Fig. 5				See Fig. 5					
	Common signal cutoff or bridged ringer cutoff	(S-Y) (Y-S)	R or R1 B or B1	See Fig. 4				See Fig. 4					
* Insulate and store. † Leads designated C1, C2, etc., in table must be bridged to leads with identical designations using QCM12A connectors or spare terminals. ‡ On-hook dialing not available.													

TABLE I  
ITT KELLOGG  
K-500, K-554, K-2500, K-2554

TELEPHONE SETS		K-500, K-554†		K-2500††		K-2554‡			
TELEPHONE SYSTEM		INDIVIDUAL OR BRIDGED CO OR PBX LINE K-1A1, K-1A2, NE-1A1, NE-1A2 OR EQUIVALENT KTS							
ITEM	LEAD COLORS	LEAD DESIGNATIONS	FROM		TO		TERMINALS		
			SET	NETWORK	SET	NETWORK			
TELEPHONE SET CONVERSIONS	(S-W)** (S-G)		F LI	C1†	G	F LI	C1	G	F I
	(R) (G)	R T			L2 F	L2 F			
	(W) (W)		GN R	C2	RR				
		A A1				L1§ G§			L1§ G§
CO or PBX line	(BL-W) (W-BL)	R1 T1			L2 RR	L2 RR			L2 F
Power supply leads	(BR-W) (W-BR)	TF1 TF2							
QUSB AND QUSCI UNITS NE-16QC CORD	(S-R) (R-S) (BL-BK) (BR-BL)	LK LK1 GND or A1 AG or A			G	G	C1	G	F I 3 *
	(O-R) (R-O) (V-O) (O-V) (BR-Y)	P3 or IR P4 or IT B5 MBS M5					* *		
	(Y-BR)	BL							
	(S-Y) (Y-S)	R or R1 B or B1							

Connect to output leads from NE-2012B transformer (or equivalent) using spare terminals or QCM12A connectors.

Auxiliary transfer contacts for optional control. See Fig. 5

Auxiliary transfer contacts for optional control. See Fig. 6

Auxiliary transfer contacts for optional control. See Fig. 5



Auxiliary transfer contacts for optional control. See Fig. 4

\* Insulate and store.  
† Leads designated C1, C2, etc., in table must be bridged to leads with identical designations using QCM12A connectors or spare terminals.  
‡ On-hook dialing not available.  
§ Used only when A lead control is required.  
\*\* On the K-2554 telephone set these colors are (W) and (G).  
†† On-hook dialing not available unless an NE-35Q3B or equivalent DIGITONE dial is used.

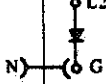



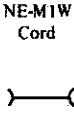

**TABLE J**  
**ITT KELLOGG**  
**564-- (BA) 30/40 M**  
**565-- (BA) 30/40 M**

TELEPHONE SETS				564-- (BA) 30/40M 565-- (BA) 30/40M									
KEY TELEPHONE SYSTEMS				NE-1A OR EQUIVALENT					K-1A1, K-1A2, NE-1A1, NE-1A2 OR EQUIVALENT				
STATION BUSY LAMP CIRCUIT				NO		YES			NO		YES		
ITEM	LEAD COLORS	LEAD DESIGNATIONS	TERMINALS			TERMINALS			TERMINALS			TERMINALS	
			FROM	KEY	NETWORK	KEY	NETWORK	FROM	KEY	NETWORK	KEY	NETWORK	
TELEPHONE SET CONVERSIONS	Line switch leads	(S-W) (S-G) (S-Y)		1B N 9	1B N	L1	SG N	L1	1B N 9	1B 9	L1	1B 9	L1
	Hold key leads	(Y) (O-BK)		M N	9 M		9 M		M N	M N		M N	
	Dial leads	(W) (W)		GN R	8	RR	8	RR	GN R	8	RR	8	RR
	Diode assembly PO522718 or diode NSQ8034L1 (1N4384) for station busy lamp	NE-M1W Cord 											
QUS1B AND QUS1C1 UNITS NE-D16QC CORD	CO or PBX line	(BL-W) (W-BL)	R1 T1		N	RR	N	RR		9	RR	9	RR
	Power supply leads	(BR-W) (W-BR)	TF1 TF2	Connect to output leads from NE-2012B transformer (or equivalent) using spare terminals or QCM12A connectors.									
	Automatic cutoff of unit when transferring to handset, and key telephone system A lead control	(S-R) (R-S) (BL-BK) (BK-BL)	LK LK1 GND or A1 AG or A		1B 1B *	L1	SG SG	L1 L2		1B 1B N	L1	1B 1B	L1 L2
	On-hook dialing	(O-R) (R-O) (V-O) (O-V) (BR-Y)	P3 or 1R P4 or 1T B5 MB5 M5		7 * 8 7	C	7 * 8 7	C		7 * 8 7	C	7 * 8 7	C
	External station busy lamp or relay control	(Y-BR)	BL	See Fig. 5					See Fig. 5				
	Common signal cutoff or bridged ringer cutoff	(S-Y) (Y-S)	R or R1 B or B1	See Fig. 4					See Fig. 4				
*Insulate and store.													

**TABLE K**  
**ITT KELLOGG**  
**2564-- (BA) 30/40 M**

TELEPHONE SETS				2564-- (BA) 30/40M†									
KEY TELEPHONE SYSTEMS				NE-1A OR EQUIVALENT					K-1A1, K-1A2, NE-1A1, NE-1A2 OR EQUIVALENT				
STATION BUSY LAMP CIRCUIT				NO		YES			NO		YES		
ITEM	LEAD COLORS	LEAD DESIGNATIONS	TERMINALS			TERMINALS			TERMINALS			TERMINALS	
			FROM	KEY	NETWORK	KEY	NETWORK	FROM	KEY	NETWORK	KEY	NETWORK	
TELEPHONE SET CONVERSIONS	Line switch leads	(S-W) (S-G) (S-Y)		1B N 9	1B N	L1	SG N	L1	1B N 9	1B 9	L1	1B 9	L1
	Hold key leads	(Y) (O-BK)		M N	9 M		9 M		M N	M N		M N	
	Dial leads												
	Diode assembly P0522718 or diode NSQ8034L1 (1N4384) for station busy lamp	NE-M1W Cord 											
QUSIB AND QUSICI UNITS NE-D16QC CORD	CO or PBX line	(BL-W) (W-BL)	R1 T1		N	F	N	F	9	F	9	F	
	Power supply leads	(BR-W) (W-BR)	TF1 TF2	Connect to output leads from NE-2012B transformer (or equivalent) using spare terminals or QCM12A connectors.									
	Automatic cutoff of unit when transferring to handset, and key telephone system A lead control	(S-R) (R-S) (BL-BK) (BK-BL)	LK LK1 GND or A1 AG or A		1B 1B *	L1	SG SG	L1 L2	1B 1B N	L1	1B 1B N	L1	
	On-hook dialing	(O-R) (R-O) (V-O) (O-V) (BR-Y)	P3 or 1R P4 or 1T B5 MB5 M5		* *		* *		* *		* *		* *
				Auxiliary transfer contacts for optional control See Fig. 6					Auxiliary transfer contacts for optional control See Fig. 6				
	External station busy lamp or relay control	(Y-BR)	BL	See Fig. 5					See Fig. 5				
	Common signal cutoff or bridged ringer cutoff	(S-Y) (Y-S)	R or R1 B or B1	See Fig. 4					See Fig. 4				
* Insulate and store. † On-hook dialing not available (see Table L).													

**TABLE L**  
**ITT KELLOGG**  
**2564-- (BA) 30/40 M**  
**2565-- (BA) 30/40 M**  
**EQUIPPED WITH AN NE-35Q3B (OR EQUIVALENT) "DIGITONE" DIAL**

TELEPHONE SETS				2564-- (BA) 30/40M 2565-- (BA) 30/40M EQUIPPED WITH NE-35Q3B DIGITONE DIAL OR EQUIVALENT										
KEY TELEPHONE SYSTEMS				NE-1A OR EQUIVALENT					K-1A1, K-1A2, NE-1A1, NE-1A2 OR EQUIVALENT					
STATION BUSY LAMP CIRCUIT				NO			YES			NO			YES	
ITFM	LEAD COLORS	LEAD DESIGNATIONS	TERMINALS			TERMINALS			TERMINALS			TERMINALS		
			FROM	KEY	NETWORK	KEY	NETWORK	FROM	KEY	NETWORK	KEY	NETWORK		
TELEPHONE SET CONVERSIONS	Line switch leads	(S-W) (S-G) (S-Y)		1B N 9	1B N	L1	SG N	L1	1B N 9	1B 9	L1	1B 9	L1	
	Hold key leads	(G) (Y) (O-BK)		F M N	9 M	RR	9 M	RR	F M N	M N	RR	M N	RR	
	NE-35Q3B or equivalent DIGITONE dial for on-hook dialing	(O-BK) (V-W) (V-G) (R) (R-G) (W)			7 8 2 1	C R	7 8 2 1	C R		7 8 2 1	C R	7 8 2 1	C R	
	Diode assembly P0522718 or diode NSQ8034L1 (1N4384) for station busy lamp circuit	NE-M1W Cord 												
QUS1B AND QUS1C1 UNITS NE-D16QC CORD	CO or PBX line	(BL-W) (W-BL)	R1 T1		N 8		N 8		9 8		9 8			
	Power supply leads	(BR-W) (W-BR)	TF1 TF2	Connect to output leads from NE-2012B transformer (or equivalent) using spare terminals or QCM1A connectors.										
	Automatic cutoff of unit when transferring to handset, and key telephone system A lead control	(S-R) (R-S) (BL-BK) (BL)	LK LK1 GND or A1 AG or A		1B 1B *	L1	SG SG	L1 L2	1B 1B N	L1	1B 1B	L1 L2		
	On-hook dialing	(O-R) (R-O)	P3 or 1R P4 or 1T		7 *		7 *		7 *		7 *			
	Auxiliary contacts for optional control	(V-O) (O-V) (BR-Y)	B5 MB5 M5	See Fig. 6					See Fig. 6					
	External station busy lamp or relay control	(Y-BR)	BL	See Fig. 5					See Fig. 5					
	Common signal cutoff or bridged ringer cutoff	(S-Y) (Y-S)	R or R1 B or B1	See Fig. 4					See Fig. 4					
* Insulate and store.														

\*Registered Trademark of Northern Electric



te

ti

